



Rope Hook & D Rings

Anchoring Points, Cam Buckle & Ratchet Straps

E-Track, Truck Straps, & Tow Straps

Twine, Bungee Cords, Tarp Straps & Stakes

Slats & Pockets & Deck Screws

Load Binders & Chain

Hooks & Quick Links

Safety Chains

Handles, Mag Straps, Cargo Bars & Nets

Door Holders & Paddle Latches

Tool & Cargo Boxes

Super Winch

Manual Winches

Bumpers & Wheel Chocks

Boat Rollers & Accessories

Landscape Trailer Accessories

Ramps

Phoenix / TowRax

HARDWARE PARTS

* = Special Order/Non-Stock

D ROPE HOOK & D RINGS

Part Number	Description	Work Load (lbs)
RH1/2	1/2" Weld on Rope Hook	N/A
RH3/4	3/4" Weld on Rope Hook	N/A
RH5/8	5/8" Weld on Rope Hook	N/A
B20	Surface Mount Rope Ring	800
B23	Surface Mount Rope Ring	400
B28	1/4" Weld on Rope Ring	1,000
B38	1/2" Bolt on Rope Ring	4,080
B38PN	Recessed Pan for B38 - Sold Separate	4,080
B38W	1/2" Weld on D Ring	4,080
B38BF	Bracket only	
B40	5/8" Weld on D Ring	6,130
B46	3/4" Weld on D Ring	9,120
B48	1" D Ring - 3" ID	15,586
B50	1" Weld on D Ring	15,586
B501	1/4" Surface Mount Rope Ring - Steel Pan & Ring, Zinc Plated	500
B601	Recessed Rope Ring	1200
B701	1/4" Recessed Rope Ring - .36 Thick	265
B801	Recessed Rope Ring Zinc	2000
B801BP	Back plate for B801 Zinc	N/A
B801AK	801 rope hook w/back plate & Hardware kit 1 per pkg	2000
B901BP	Back plate for B901D	N/A
B901D	Rotating D Ring	5000
B99	Recessed Rope Ring w/ Flush Plastic Ring	500
B56723	1" Eye Bolt w/ 3/8" shaft	1,400
B01005	4-Pack Tarp Hooks	N/A
B2447	Zinc Rope Hook - 3 1/4" long, 9/32" holes, 3/8" round cross section	N/A
02020	B601 Rope Ring Clam Pack - 4 Pack	285 lbs ea.
02030	B801 Rope Ring Clam Pack 1 ea	2000
B2447NHP	Tarp hook weld on plain 3/8" x 3/14"	N/A
B38RP	1/2" FORGED D-RING ZINC W/2 HOLE MT BRKT INCLUDES RECESSED PAN 3.5" X 3.375" OD	N/A
B2402AL	ALUMINUM CHAIN LOOP 1/2" DIA 2 1/8 OPENING 1 3/4 DEPTH CAST	N/A

			
B801AK	B901BP	B01005	B38RP
			
B801BP	02020	02030	B2402AL

Anchoring Points

Part Number	Description
T-91506	Zinc Eye Bolt Anchor 1 Pk
T-91507	Stake Pocket Anchor Point 1 Pk
T-9154700	Fold Away Black T Cleat, 2-Pack WSL
T-91501	Fold Away Chrome T Cleat, 2-Pack
T-13400	Chrome Universal Anchoring System Pair
T-92509	Chrome Universal Anchoring Points Pair
T-9252200	Chrome Over-size Truck Anchor
T-9150000	Anchor point, Mini Cleat Rope Hook - Zinc Pair
T-9154800	T-Rope Hook - Pair

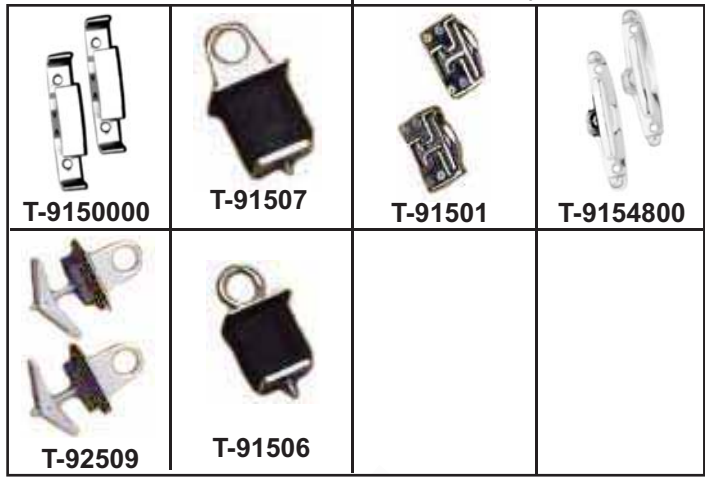

Cam Buckle Tiedowns

Part Number	Description	Work Load (lbs)
T-91802	1" x 6' Cambuckle Tie Down - 4 Pack	400
T-11562	Ultimate 2" x 6' Cambuckle Tie Down - Pair	1000
T-11506	Ultimate 2" x 6' Cambuckle Tie Down - Pair	830
T-10333	1" x 10' Cambuckle Tie Down w/ hooks, Red - Sold each	300
T-10342	1" x 6' Motorcycle Tie Down w/ hooks - 2 Pack Cam Buckle, Black	400
T-10344	1" x 12' Cambuckle Tie Down, Black - Sold each	400
T-11506	ULTIMATE 2" X 5.5' CAMBUCKLE PAIR TIE DOWN 2500# YELLOW	830
T-11542	Ultimate Motorcycle Tiedown Pair - Orange 1" x 6'	430



1" & 1-1/2" Ratchet Tiedowns

Part Number	Description	Work Load (Lbs)
T-11502	Ultimate Ratchet Tiedown - Blue, 1" x 6'	600
T-11516	Ultimate Ratchet Tiedown Pair - Yellow, 1" x 10'	1100
T-11517	Ultimate Ratchet Tiedown, sold each - Yellow, 1.5" x 15'	1830
T-11521	Ultimate Padded Grip Ratchet Tiedown Pair - Red, 1" x 6'	600
T-11701	Ratchet Tiedown, No Hooks, sold each - 1" x 12'	500
T-11702	Ratchet Motorcycle Tiedown Pair - 1" x 6"	500
T-11705	Ratchet Tiedown w/ Hooks - 1" x 14'	500
T-1227000	Ratchet Tiedown - 1" x 10'	300
T-9210500	Ratchet Tiedown 4 Pack - Blue, 1" x 10'	300
T-9211200	Ratchet Tie Down (4), Stretch Cord (4), Tarp Straps (2) & Cable Ties (50) Multi-Pack w/Carrying Case	300



ANCHORING POINTS, CAM BUCKLES

* = Special Order/Non-Stock

D E-TRACK, TRUCK STRAPS & TOW STRAPS



Part Number	Mfg No.	Description
B01077	642001	E Track Tiedown - 2" x 20' Ratchet
B01080	660001	E Track Tiedown - 2" x 6" /w Rope
HET	43002	Horizontal E Track - 10' Gray Steel 5" Wide
HET8730	8730	PLASTIC END CAP FOR E TRACK
HET8066-3	8066-3	ALUMINUM BEAM FOR E TRACK 96" TO 120" WIDE TRAILERS
HET1845	1845	1845 WOOD BEAM SOCKET FITS 2X
B01090		D-RING FITTING FOR E-TRAC WL 1800



Part Number	Description
37032	Combo Ratchet winch bar NEW
1903005LH	weld on truck strap winch 4"



Part Number	Description
10091	Strap winder
B1903065	Black Combination Winch Bar
T41903005	Weld on truck strap winch - 4"
T3012YDR	30' x 4" Truck Strap w/ Delta Ring
T3012YFH	30' x 4" Truck Strap - Flat Hook
T3012YSW	30' x 4" Truck Strap Sewn Eye

Part Number	Description
1903030	SLIDING WINCH STD BUYERS USE WITH TRACK 1903040
1903040	TRACK, SLIDING WINCH, 1/4" x 72"

Part Number	Description
T-10152	Tow Strap 2"x20' w/Sewn eye loops 20000 Clam shell pkg.
T-1017800	2" x 20' Tow Strap w/ Sewn Eye Loops 17000 Sleeve Pkg.
T-91616	5/8" x 14' Tow Rope w/ Hooks 5K BS
T-10146	2" x 15' Tow Strap w/ Hooks 10K BS
T-10176	2" x 20' Tow Strap w/ Hooks
63030	Tow hook black w/ bolts

* = Special Order/Non-Stock

Part Number	Mfg No.	Description
T-05530		RACK- RATCHET 8' RETRACTABLE STRAP 500lbs LOAD LIMIT This is a permanently mounted tie-down, ideal for ladder and pipe racks. 8' length allows for multiple applications, while the D-Ring allows for more holding options. Molded handle gives a more secure grip and the coated double J-hooks provide a nonmarring feature. Mounting hardware is included.
RL10301		Rope Lock Tie Down



Part Number	Description
TD01	Tow Dolly Strap - Double Hook
TD02	Tow Dolly Ratchet Buckle
T-12755	25" Ratchet Strap Wheel Tiedown
T-1275000	6,000lbs Tire Tiedown - 9"



2" Ratchet & Axle Strap Tiedowns

Part Number	Description
T-11525	Ultimate Ratchet Tiedown - Yellow, 2" x 25' 10,000 Lbs
T-272FB	RATCHET STRAP 2X27 10K FLAT HOOK BULK 3,300WL
T8TWS	2" X 8' REPLACEMENT STRAP W/TWIST SNAP HOOK ON ONE END NO RATCHET ASY.
T22AS	24" AXLE STRAP 2" w/ D RINGS ,2000WLL 6K B/S 04223
T-04110	AUTO TIEDOWN RATCHET 10'X2" 6K BS W/TWIST SNAP HOOKS CLAM PAC
T-04622	27' X 2" Ratch Tie-Down w/J-Hook 10K 3300WII
T-04623	27' X 2" Ratch Tie-Down w/flat hook 10K 3300WII
T-04223	Axle strap 24" 2K 6K Break Strength Packaged
T-05506	15' x 1" Ratchet 4 Pack

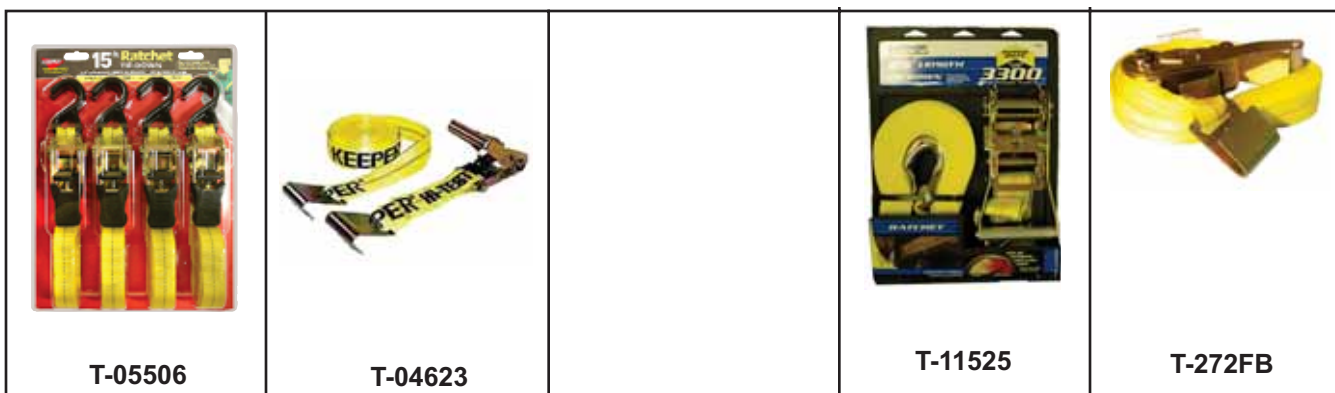

TRUCK STRAPS & TOW STRAPS

* = Special Order/Non-Stock

D
TWINE, BUNGEE CORDS,

Part Number	Description
T2200	Binder Twine - 2,200' Ball
T250	Braided Nylon Twine - approx. 1030' Spool - 1/4lbs - Yellow
T3600	Baling Twine - 3,600 Roll - Orange
T-9165000 Mfg # 07710	California Truck Rope 3/8"x50', 2700lbs Black & Orange
TS15	15" Rubber Tarp Strap - w/ 2 Hooks
TS20	21" Rubber Tarp Strap - w/ 2 Hooks
TS31	31" Rubber Tarp Strap - w/ 2 Hooks
TS9	9" Rubber Tarp Strap - w/ 2 Hooks
TSH9225	2.5" S Hook (For Tarp Strap) Replacement
T-90010	10 Piece Bungee Cord Assortment colors
T-9008400	24 Piece Bungee Cord Assortment colors
T-9009500	6 Piece Bungee Cord Assortment colors
T-9133800	7 Piece Triple Strength Bungee Cord Assortment 2-18", 2-24", 1-32", 1-40", and 1-52"
T-9133900	6 Piece Tarp Strap Assortment
T-92018	Stretch Cord - (2) 18"
T-92055	12 PK CAMO BUNGEE CORDS IN A JAR (3)18" (2)24" (1)32" (1)40" (3)MINI (2) CANOPY
T-92324	Stretch Cord - (2) 24"
T-93324	Adjustable Triple Strength Stretch cord 12" to 24"

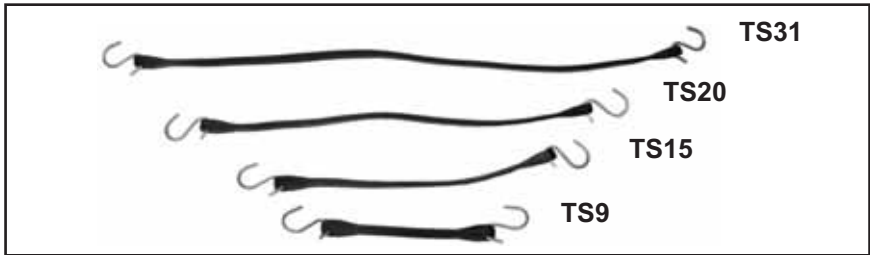
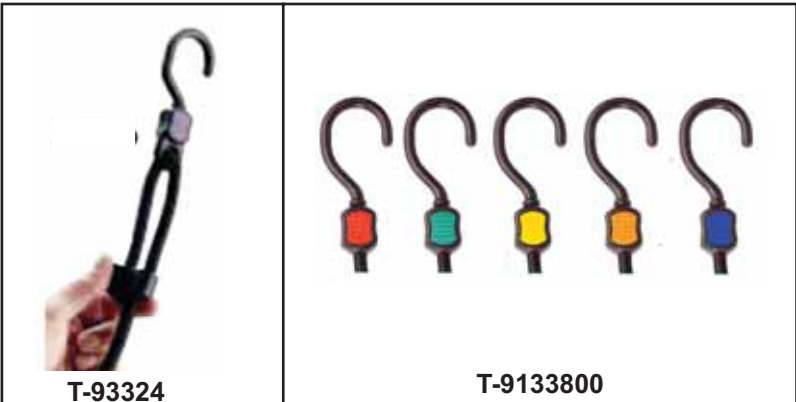

Ideal storage cover for wood, boats, swimming pools, outdoor grills, outdoor furniture, truck beds and much more. Rustproof metal grommets with rope reinforced hems for extra strength



Part No.	Description	Color
T-9016500	8'x10' Tarp Cover	Blue
T-9016600	10'x12' Tarp Cover	Blue
T-9016700	12'x16' Tarp Cover	Blue
T-9016800	16'x20' Tarp Cover	Blue

* = Special Order/Non-Stock



Part Number	Description
4011	11" Bayer Style Stake - Only fits 410 pocket
4012	12" Bayer Style Stake - Only fits 410 pocket
4018	18" Bayer Style Stake - Only fits 410 pocket
4024	24" Bayer Style Stake - Only fits 410 pocket
4036	36" Bayer Style Stake - Only fits 410 pocket
4042	42" Bayer Style Stake - Only fits 410 pocket
4048	48" Bayer Style Stake - Only fits 410 pocket
4060	60" Bayer Style Stake - Only fits 410 pocket
410	Pocket for Bayer Style Stake
411	Trimmed 2x4 Sleeve Tip - Fits 410 pocket
4212	STAKE FLEMMING STYLE 12" STEEL
421-B	FLEMMINGS Style Sleeve Tip for Trimed 2X4
4224	STAKE FLEMMING STYLE 24" STEEL
4248	STAKE FLEMMING STYLE 48" STEEL
483X	POCKET FLEMMING STYLE 12GA. WELD ON
B2588BZ	Zinc Side Rail Latches
B2589BZ	Zinc Side Rail Corner Latch
B06025	STRAIGHT SIDE SEC LATCH ZINC VIZ PAC
B06030	Corner Security Latch Set, Zinc VIZ PAC
BSA1447WDNH	47" Stake Rail - Measurements fit B2373K ONLY
LS1665120	6.5W x 120L" Liner Slat
LS166545	6.5W x 44.62L" Liner Slat
B2373C	3.5 X 1.75 X 4" Stake Pocket
B2373K	3 X 1.5 X 4" Stake Pocket
B2374G	Tapered Bolt On Stake Top: 3" x 1.5" - Bottom: 2.125" x 1.5" Thickness: 0.125" - Depth: 2.5"
TFX225	Torx Deck Screw 1/4-20-2.25"

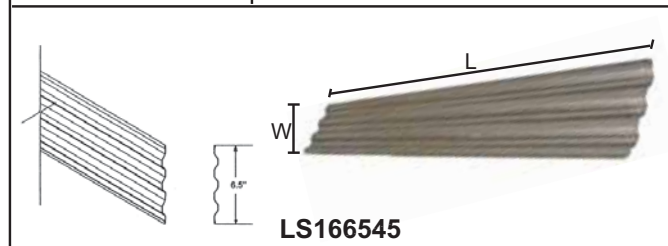
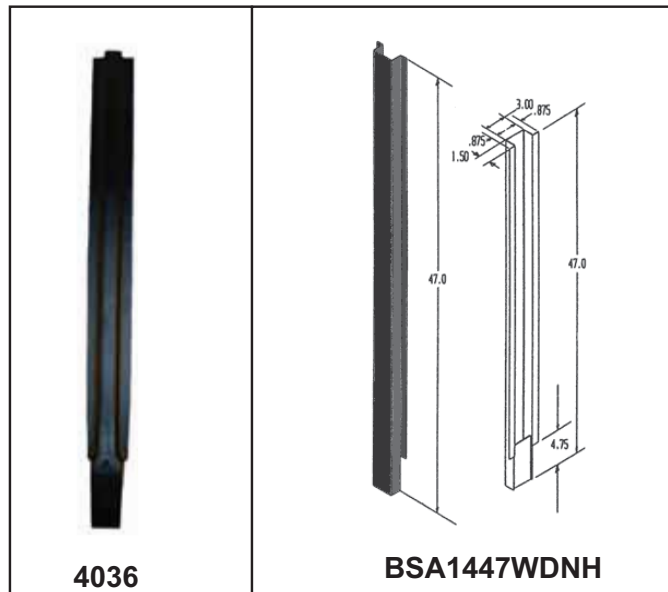
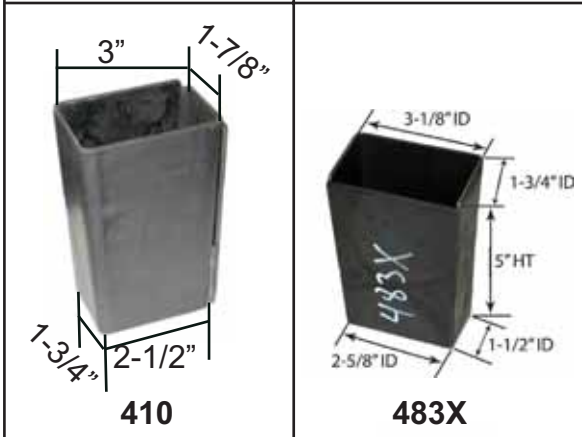
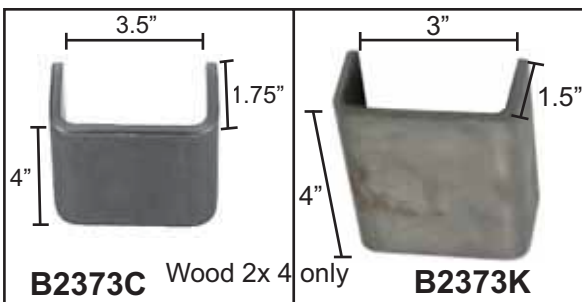

SLATS AND POCKETS

* = Special Order/Non-Stock

D LOAD BINDERS & CHAIN

Part Number	Description	Min. Chain Size	Max. Chain Size	Work Load (WLL)
LBR250	Import Ratcheting Load Binder	1/4"	1/4"	2,600
LBR3812	Import Ratcheting Load Binder	3/8"	1/2"	9,200
LBR5638	Import Ratcheting Load Binder	5/16"	3/8"	6,600
LB5638S	Lever Style Binder	5/16"	3/8"	5,400
DLBR5638	Domestic Ratcheting Load Binder	5/16"	3/8"	5,400
LBA5638 Kenedyne	10049 LOAD BINDER LEVER TYPE ADJUSTABLE HOOK WITH SAFETY PIN FOR LEVER	5/16"	3/8"	5,400

Import Transport Chain

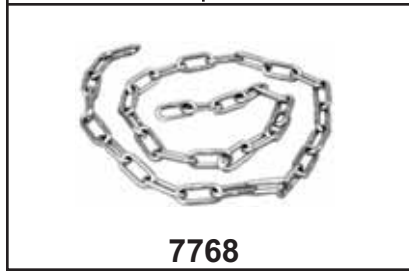

Part Number	Description	Grade	Chain Size	Chain Length	Work Load (WLL)	Design Factor
LBC3820	Transport Chains for Load Binders /w Grab Hooks	43	3/8"	20'	5,400	3:1
LBC382070	Transport Chains for Load Binders /w Grab Hooks	70	3/8"	20'	6,600	4:1
LBC51620	Transport Chains for Load Binders /w Grab Hooks	70	5/16"	20'	4,700	4:1
LBC51616	TRANSPORT CHAIN	70	5/16"	16'	4,700	4:1

Domestic transport Chain

Part Number	Description	Grade	Chain Size	Chain Length	Work Load (WLL)	Design Factor
D3820G7	Transport Chain	70	3/8"	20'	6,600	4:1
D5160G7	Transport Chain	70	5/16"	20'	4,700	4:1

Part Number	Chain Size	Chain Length	Grade	Work Load (WLL)	Container
C143	1/4"	100'	30	1250	Bucket
C3163	3/16"	250'	30	1250	Bucket
CA250 #	1/4"	Per FT.	30	1250	Chain per FT
C1435	1/4"	400'	30	1250	Barrel
C38363	3/8"	63'	30	2650	Bucket
CA383#	3/8"	Per FT.	30	2650	Chain per FT
C387	3/8"	75'	70	6600	Bucket
7768	3/16"	3'	SS	800	Length
C5163	5/16"	100'	30	1900	Bucket
C5167P	5/16"	100'	70	4700	Bucket
CA126 #	1/2"	Per FT.	70	9400	Chain per FT
CA5167 #	5/16"	Per FT.	70	4700	Chain per FT
CA5163 #	5/16"	Per FT.	30	1900	Chain per FT
C51635	5/16"	550'	30	1900	Barrel

Non returnable once cut. 4:1 Design Factor

Both grade 43 & 70 meet DOT / CVSA / CHP Requirements.

Net weight of cargo to be secured in lbs: & How many chains required for load								
Chain Grade	Size	20,000lbs	25,000lbs	30,000lbs	35,000lbs	40,000lbs	45,000lbs	50,000lbs
Transport chain	1/4	4	4	5	6	7	8	8
	5/16	3	3	4	4	5	5	6
	3/8	2	2	3	3	4	4	4
	1/2	1	2	2	2	2	2	3
High test Chain	1/4	4	5	6	7	8	9	10
	5/16	3	4	4	5	6	6	7
	G43 3/8	2	3	3	4	4	5	5

WARNING

Do not use for overhead lifting.

Do not use if chain links or component parts are visibly worn, damaged or distorted

NOTE: These chains are not approved for overhead lifting.

Only Alloy (Grade 80) chain is approved for overhead lifting applications.

WARNING: Do not exceed the working load limit. Inspect all parts for distortion, cracks or damage prior to use.

Warnings, Cautions, Inspection and Proper Use of Chain products and components are designed and built for rugged lasting service. As with any quality product certain precautions and standards of treatment should be observed. Proper care will extend the useful life of the product.

INSTRUCTIONS REGARDING COMPONENTS AND FITTINGS

Components, such as hooks or shackles, should have at least the same working load limit (rated capacity) as the chain with which they are used. If not, the assembly shall be rated to the capacity of the weakest component.

WARNINGS AND CAUTIONS

- The use of chain is subject to certain hazards that cannot be met by mechanical or manufacturing means, but only by the exercise of intelligence, care, and common sense
- Do not exceed the working load limit of the chain or any component
- Chemically active environments may adversely affect chain and components. Do not use in highly acidic or caustic environments. Campbell should be contacted if the chain will be exposed to chemically active environments during use
- High and low temperatures will affect chain and components.
- Chains used in certain applications are subject to governmental regulations. Please follow all Federal, State and/or Local Department of Transportation, OSHA, or other applicable standards and regulations when using Campbell products
- Never field weld or repair chain

INSPECTION

Regular inspections should be conducted on chain to detect damage or deterioration from use. The chain should be inspected for any of the below conditions. If present, the chain should immediately be removed from service.

- Cracks in the chain or any component
- Excessive nicks or gouges
- Excessive wear. Chain should be removed from service if the thickness at any point on the link is below the value shown in the
- Stretched, bent, twisted, or distorted chain links or components
- Excessive corrosion

NOTICE: The product specifications and dimensions are as accurate as possible at the time of printing. However, because we are continually improving the quality and design of our products, they can change without notice.

* = Special Order/Non-Stock

D HOOKS AND KEEPERS

Part Number	A	B	Description	Grade	(WLL)	Design Factor
LBH1/4	1/4"	5/16"	Clevis Grab Hook for Transport chain	70	3600	4:1
LBH3/8	3/8"	1/2"	Clevis Grab Hook for Transport chain	70	7500	4:1
LBH5/16	5/16"	7/16"	Clevis Grab Hook for Transport chain	70	5400	4:1



Part Number	Description	WLL	Design Factor
J-54	1/4" Clevis Sling Hook w/ Latch	2750	4:1
J-55	5/16" Clevis Sling Hook w/ Latch	4300	4:1
J-56	3/8" Clevis Sling Hook w/ Latch	5250	4:1
J-57	1/2" Chain Sling Latch Hook w/ Latch	9000	4:1
2255	1/4" Forged Sling Eye Hook w/ Latch	1950	4:1



Part Number	Description	WLL	Design Factor
TSL1	3/8" Safety Chain S-Hook	750	3:1
TSL2	7/16" Safety Chain S-Hook	1250	3:1
TSL4	17/32" Safety Chain S-Hook	1900	3:1
TSSL	Safety Latch Replacement for TSL1 only		
150-0041	Neoprene Safety Cable Keeper		



J-27	7/16" Zinc S-Hook for Breakaway Need rubber keeper to be Ca. Legal.	3,500	
10555	Dico S-Hook		
1639	1/8" Quick Link	220	4:1
1640	3/16" Quick Link	660	4:1
1643	1/4" Quick Link	880	4:1
2529	5/16" Quick Link	1760	4:1
2530	3/8" Quick Link	2200	4:1
2531	1/2" Quick Link	3300	4:1

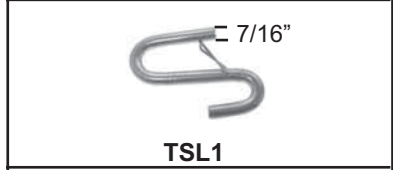

Part Number	Chain Size	Description	WLL	Design Factor
B2409B	5/16"	Double Clevis Chain Link	3,900	4:1
B2409C	3/8"	Double Clevis Chain Link	5,400	4:1
BS34	3/4"	Bow Shackle	6,500	4:1



Part Number	Description	WLL
LBCA18	18" Chain Anchor 3" D ring on one end 5/16" grab hook on other 16,200 BS 5,400WLL	2,600

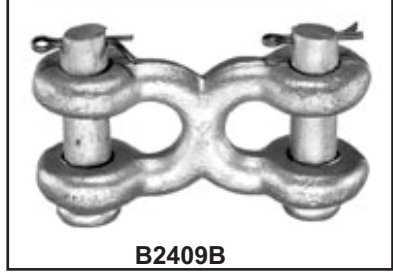



SC50B

Part Number	Description	GTW
SC38B	3/8" Safety Chain Mount Bracket	Rated
SC50B	1/2" Safety Chain Mount Bracket	Per
SC58B	5/8" Safety Chain Mount Bracket	Chain & Welds

Part Number	Description	Breaking Strength
B03835SC	3/8" CL III Safety Chain w/ Clevis Hook 35" Long Grd 30	10,000
40604	Heavy Duty Safety Chain	5,000
7030	36" Safety Cable	7,000
2829DATSC	40" Safety Cables w/ Hook & Safety Latch - 2 Pack Master Lock Brand	5,000



2829DATSC



B03835SC



7030



34141

Part Number	Description	GTW
34141	Class IV Safety Chain Loop	10,000
70555	Class II Safety Chain Loop	4,000

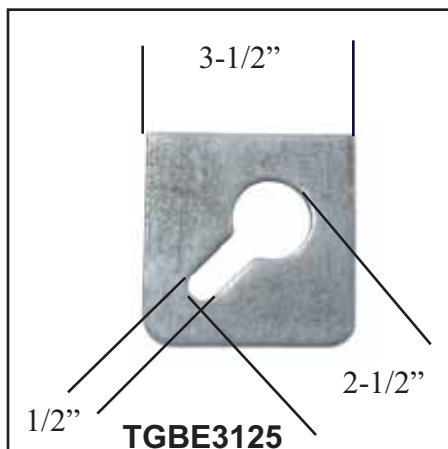

TGBE3125





Part Number	Description	GTW
TGBE3125	5/16" Banjo Eye	

D
SAFETY CHAINS

* = Special Order/Non-Stock

D SAFETY CHAINS

 SC142430WSH	1/4" X24" GRD 30 SAFETY CHAIN W\ WIRE SAFETY LATCH 5000# B/S
 SC143670WSH	1/4" X36" GRD 70 SAFETY CHAIN W\ CLEVIS SAFETY HOOK 12,600 # B/S
 SC383670WCH	3/8"X 36" GRD 70 SAFETY CHAIN W\CLEVIS SAFETY HOOK 26,400 # B/S
 SC5163670WCH	5/16 X 36" GRD 70 SAFETY CHAIN W\ CLEVIS SAFETY HOOK 18,800 # B/S
 FE8171-1	CLUSTER HOOK RTJ CAR TIE DOWN (NO CHAIN INCLUDED) R HOOK FOR GM & CHRYSLER T HOOK FOR FORD J HOOK FOR IMPORTS 11,600 BREAK STRENGTH 3,900 WORK LOAD LIMIT

	B2426FS HINGE, FORMED STRAP W/3.25" LEAF/GRS FTG		FSP150 WELD ON "BULLET" HINGE, STEEL W/ STEEL PIN & BRASS BUSHING. LENGTH 6"
	B2426FSL HINGE, FORMED STRAP W/5.25" LEAF		H412550LH BUTT HINGE, 4" L x 1 1/4" W, LEFT. FLUSH MNT WING STYLE, ZINC PLT STEEL, STAINLESS STEEL PIN 1/2"
	FBP100GF WELD ON "BULLET" HINGE, STEEL W/BRASS PIN, BRASS BUSHING, & GREASE FITTING. LENGTH 4"		H412550RH BUTT HINGE, 4" L x 1 1/4" W, RIGHT. FLUSH MNT WING STYLE, ZINC PLT STEEL, STAINLESS STEEL PIN 1/2"
	FBP150GF WELD ON "BULLET" HINGE, STEEL W/BRASS PIN, BRASS BUSHING, & GREASE FITTING. LENGTH 6"		S72 Piano Hinge 3" x 72"
	FSP100 WELD ON "BULLET" HINGE, STEEL W/ STEEL PIN & BRASS BUSHING. LENGTH 4"		

* = Special Order/Non-Stock

Part Number	Description
BC2399	11.5" Chrome Grab Handle
BZ2797	Zinc Folding Step or Handle



Part Number	Description
T-95001	36" x 48" Roof Cargo Net
T-95005	60" x 78" Cargo Bungee Net
T-95006	Adjustable Cargo Net, Fits all Pick-up trucks
T-95012	45" to 60" x 24" Hammock Style Net
1980001	Space Master Cargo Organizer



Part Number	Description
T-91420	40" - 74" Adjustable Cargo Bar w/ Net
T-19700	40" - 74" Cargo Bar, Screw Adjustable
19702	40" to 70" Ratcheting Cargo Bar
T-9503100	Turbo Fence, Full Size Trucks



Part Number	Description
B3002879	Torsion ramp spring LH
B3002880	Torsion ramp spring RH

D
CARGO CONTROL

* = Special Order/Non-Stock

D DOOR HOLDERS & PADDLE LATCHES

Part Number	Description
DH5006	6" T Style Door Holders - Pieces 1 & 2
600	White Female Door Socket (No Screws)
620	2" Aluminum Door Hold - 2 Pieces
620-01	4" Aluminum Door Hold - 2 Pieces

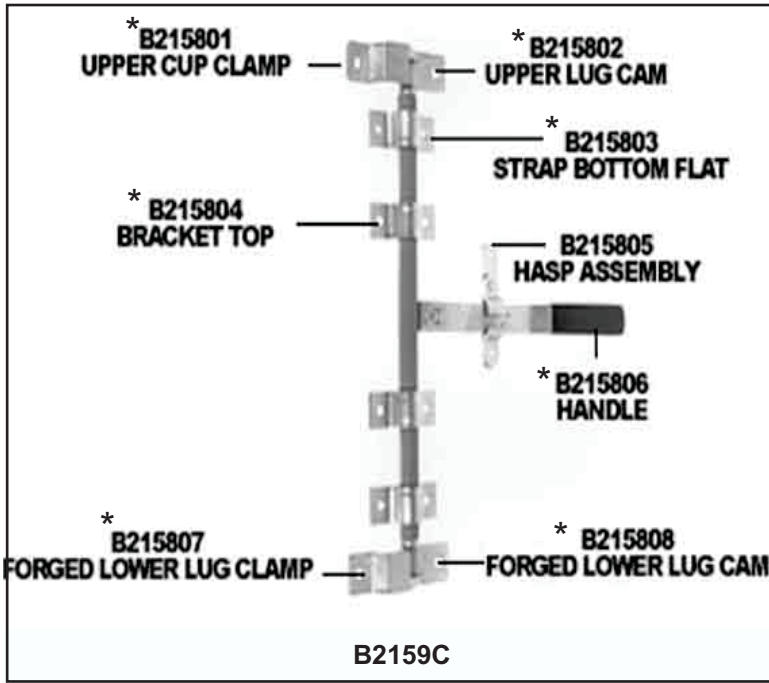

Part Number	Description
WJ195	4" Easy Grip Rubber Hood Catch
WJ201A	4 7/8" Rubber Hood Catch w/ Brackets & Pin *No Bumper
WJ205	6" Heavy Duty Rubber Hood Catch
BL2392	Locking T Handle
BL2394	Locking L Handle
B04025	Jr Size Locking Paddle Latch
B04035	Heavy Duty Locking Paddle Latch
L8815	Folding T Handle Latch
L8815KC	Cyl & Keys CH545, Fits L8815 Latch
L8816	Single Point Folding T-Latch, SS, w/ Blind Studs
L8855	Folding T Latch Lock Blind Stud Single Latch Point Stainless Steel Flush Mount Replacement For Truck Boxes
TL382	Tipper Latch Assembly Weld On
TGL3410ST	Tail Gate Latch Assembly
B2595	1/2" Zinc Spring Latch
B2596	3/4" Heavy Duty Spring Loaded Latch
B2159C	Cam Action Door Latch Kit 3/4" Pipe not incl
TGC32508VKSA	Tailgate Cylinder Air
19CH545	CYL & KEYS CH545 FITS SOME PADDLE LATCHES
B215805	Zinc Hasp Assy.
B1430-01	WELDED BAR LOCK ASBLY.36"

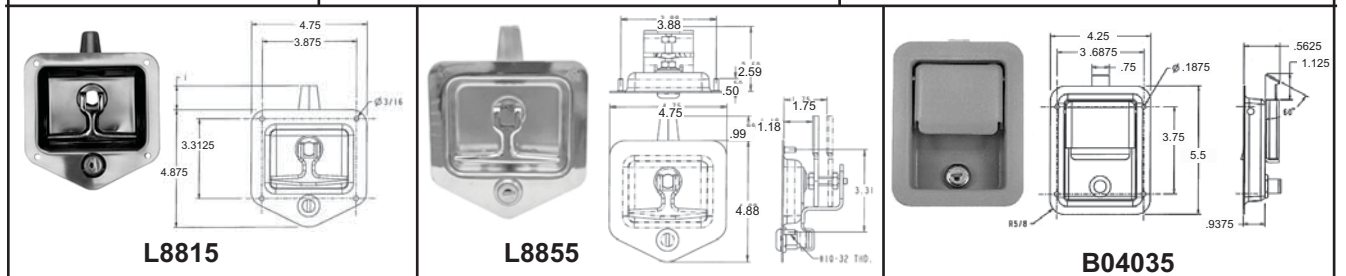
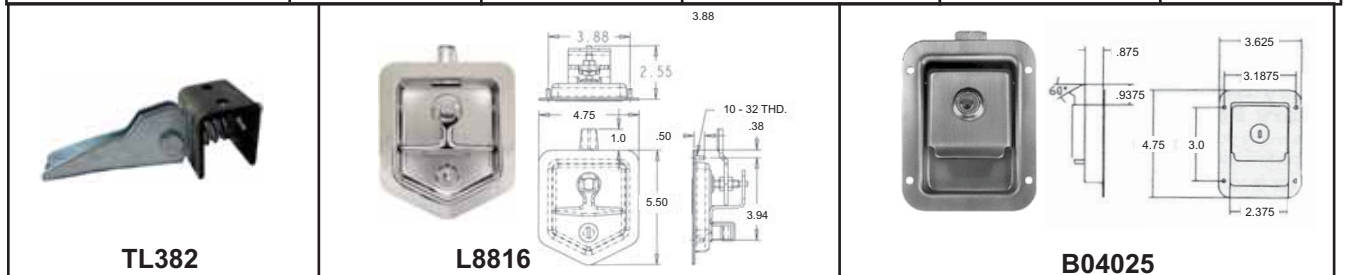

* = Special Order/Non-Stock

Black Steel Underbody Toolboxes

- * 14-gauge steel box, 12-gauge steel door (12-gauge steel box, 12-gauge steel door on 66" toolboxes).
- * Recessed/beveled door.
- * Rain channel design.
- * 1/2" door gasket (automotive-style).
- * Stainless steel continuous hinge is watertight and rustproof.
- * Reinforced door backbone strengthens the integrity of the door and protects the latch mechanism.
- * Stainless steel locking T-handle latch.
- * Replaceable doors.
- * No. 1702325 features double doors.
- * Powder coated for corrosion resistance.
- * Also available in white and with rotary paddle latch.

Black Steel Underbody Toolboxes			
Part #	H x D x W Size	# Latches	Weight
B1702300	18" x 18" x 24"	1	67 lbs.
B1702303	18" x 18" x 30"	1	80 lbs.
B1702305	18" x 18" x 36"	1	92 lbs.
B1702310	18" x 18" x 48"	2	118 lbs.
B1702315	18" x 18" x 60"	2	143 lbs.
B1702325	18" x 18" x 72"	2 (2 doors)	156 lbs.
B1702100	Same as B1702300 except rotary paddle latch		



B1702300

Black Steel Box with Polished Stainless Steel Door

- * 14-gauge black powder coated steel box with 14-gauge bright Annealed stainless steel door (mirror finish)
- * Recessed/beveled door
- * Rain channel design
- * 1/2" door gasket (automotive style)
- * Stainless steel continuous hinge is watertight and rustproof
- * Stainless steel locking T-handle latch
- * Reinforced door backbone strengthens the integrity of the door and protects latch mechanism
- * No surface bolts or weld marks on door
- * Replaceable doors; full open door (remove cable and door opens completely)
- * Individually boxed for shipping

Boxes with Polished SS Door		
Part #	H x D x W Size	Weight
B1702700	18" x 18" x 24"	72 lbs.
B1702705	18" x 18" x 36"	101 lbs.
B1702710	18" x 18" x 48"	110 lbs.



B1702700

Trailer Tongue Boxes

- * Designed to mount to the front of A-Frame style trailers
- * Steel- constructed of 14/12-gauge powder coated steel with a dual striker stainless steel paddle latch
- * Aluminum-constructed of .063 mil diamond tread aluminum
- * Polymer-constructed of rotationally molded high-density polyethylene
- * These toolboxes offer an easy way to add secure storage to your trailer.

Trailer Tongue Boxes						
Part No.	Material	A	B	C	D	Weight
B1701280	Steel	34"	20.75"	14.25"	16"	95 lbs.
B1701281	Steel	26"	14"	13.25"	12"	65 lbs.
B1701285	Steel	48"	33"	16"	16"	115 lbs.
B1701380	Aluminum	34"	20.75"	14.5"	15"	20 lbs.
B1701385	Aluminum	49"	37"	15"	18.5"	30 lbs.
B1701680	Polymer	36"	17.85"	20"	14.63"	21 lbs.



B1701680



B1701380

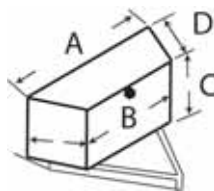

Topside Toolboxes

- * Large 14" tall door opening and the recessed door provide easy access to spacious storage area
- * Full length stainless steel continuous hinge on doors offers a sturdy, durable and smooth performance
- * Reinforced door backbone strengthens integrity of door and protects latch mechanism
- * Rain channel and door gasket keep moisture and dust out
- * 16-gauge steel box; 14-gauge steel doors
- * Stainless steel folding T-handle with lock for security (two per door on 96")
- * Optional trays require no drilling; easy to remove
- * White or black powder coat finish
- * All mounting hardware included
- * Support legs mount directly into the bed floor, not into the fender
- * Thick 3" wide rubber pad protects truck from scratches
- * No drilling in side rails; J-bolts fasten under bed lip

Topside Toolboxes			
Part No.	H x D x W Size	Color	Weight
B1702840	**16" x 13" x 72"	White	105 lbs.
B1702850	**16" x 13" x 88"	White	120 lbs.
B1702860	**16" x 13" x 96"	White	128 lbs.
B1702960	16"x13"x96"	Black	
B1702840TRAY	**Tray for 72" Steel Topside Toolbox	White	11 lbs.
B1702850TRAY	**Tray for 88" Steel Topside Toolbox	White	14 lbs.
B1702860TRAY	**Tray for 96" Steel Topside Toolbox	White	15 lbs.



B1702840TRAY



B1702840

D

TOOL & CARGO BOXES

* = Special Order/Non-Stock



SUSD24SK
SUSD36SK
SUSD48SK

SUSD24SK	24" W TOOL BOX ADJ.SHELF , FITS 18x18 BOX GALV STEEL
SUSD36SK	36" W TOOL BOX ADJ.SHELF , FITS 18x18 BOX GALV STEEL
SUSD48SK	48" W TOOL BOX ADJ.SHELF , FITS 18x18 BOX GALV STEEL

SHELF ONLY BOX NOT INCLUDED



B1705103

B1705103	18X18X30 ALUMINUM diamond plate BOX
B1705105	ALUM UNDERBODY 18X18X36 POLISHED DIAMOND PLATE BOX W/T- HANDLE .100 MIL BOX
B1705110	ALUM UNDERBODY 18X18X48 POLISHED DIAMOND TREAD W/T- HANDLE .100 MIL BOX
B1703350	TOOLBOX UNDERBODY 14" x 12" X24" BLACK POWDERCOAT W\ss T- HANDLE 14GA STEEL BOX 12GA DOOR



B1703350

RS2	Truck Step 2 rung fold down black
-----	-----------------------------------

Universal Mounting Brackets

- * Constructed of heavy duty 3" C-channel A-36 steel
- * Black powder-coated for corrosion resistance
- * Universal hole pattern for quick and easy mounting
- * Available with welded braces or bolt-on braces

Universal Mounting Brackets		
Part No.	Size	Weight
B1701005	18" x 18" Welded Bracket	24 lbs.
B1701010B	18" x 24" Universal Underbody Mounting Brackets, Bolted Braces	
B1701005B	18" x 18" Universal Underbody Mounting Brackets, Bolted Braces	
B1701015	24" Box Mount Brkts	



B1701005B



TBP001

TBP001	SIDE MOUNT TOOL BOX BRACKETS
--------	------------------------------

D TOOL & CARGO BOXES

 SW06212	 SW06302
 SW1520	 SW1515A
 SW2050	 SW2236
 SW2055	 SWGP2300
 SW2550	 SW2227A
 SWT2000	 SWT1500
 SWATV3000	 SWS5000
 SWEPI9	 SW2008
 SW2270 SW2271	 SW2302287

Part Number	Description
SW03000	1,000lbs Crane Winch - 12V DC
SW06212	Wireless Remote Control - 150' Range - ATV1800/2300/3000 new version
SW06302	Wireless Remote Control Upgrade - Digitally encoded for interference free operation. Compatible with handheld 3-Pin style. Fits pre-2004 S-Series, X-Series, GP-Series, EP-Series, and Husky Series Winches.
SW06702	Wireless Remote Control Upgrade - 7-Pin Style. See above. post 2004
SW1515A	Remote 12' Handheld Switch & Solenoid Assembly. Fits EX1, X1, X2, S2500, and S3500.
SW1520	Trailer Wiring Kit - Fits EX1, X1, X2, X3, S3000, and S4000 Winches
SW1551	6-10AWG Wire Quick Disconnect 1 pair
SW2236	2-4 AWG Wire Large Quick Disconnect. 1 pair
SW06202	Fits T1500,T2000, ATV2000, ATV3000 early models wireless remote
SW2007	Wiring Front Rec. X6/X9 - S6/S9 quick disconnect
SW2008	Trailer Wiring Kit - SWS5000 X6, X9, S9000, S6000, EP9000, EP6000 Winches quick disconnect
SW2050	Large Cradle - Fits all 6000 & 9000 Winches. Up to 13" and 8" wide. 2" Receiver.
SW2055	Small Cradle - Fits X & S Series up to S5000 - 7.5" Long x 8" Wide. 2" Receiver
SW2212A	12,000lbs Pulley Block w/ Hook. used with X6 & S6000.
SW2229A	9,000lbs Pulley Block. Use with S5000 and X3. DO NOT USE WITH 6K OR HIGHER WINCHES
SW2231	T-Series Hawse. Fits old style T1500 and ATV2000 Series.
SW2227A	PULLEY BLOCK 8,000#
SW2270	15' HAND HELD REMOTE W/MATING SOCKET 7 PIN
SW2271	30' HAND HELD REMOTE W/MATING SOCKET 7 PIN
SW2302277	Roggle Solenoid Upgrade Kit. Needed to upgrade T-Series Winches to a Roggle Switch or to a Wireless Remote.
SW2375	Mount Kit ATV HDA Rancher TRX350 '00-04
SW2379	Mount Kit ATV HDA TRX500 Rubicon '01-04
SW2381	Mount Kit ATV HDA TRX400 Foreman '95-01 - TRX450S/ES 98-04
SW2546	2" Receiver Shackle Bracket
SW2550	Cover 2549 Roller Fairlead
SW7750A	20,000lbs Pulley Block Boxed. use with X9, S9000 & Husky Winches
SW89-32332	Circuit Breakers for S5000 Four on Buss Bar
SWATV2500	ATV2500, 12V DC Electric Winch - 2,500lbs, Water Resistant
SWATV3000	ATV3000, 12V DC Electric Winch - 3,000lbs
SWEPI9	9,000lbs High Performance Winch - Includes Pulley Block, 125' Wire Rope. 15' Hand Held Switch, 3 Pin Roller Fairlead - Auto Brake
SWGP2300	2,300lbs 12v DC Electric Winch. 15' Handheld Remote. 60' Wire Rope, 5/32" Roller Fairlead
SWGP3000	3,000lbs 12V DC Winch w/ brake. 15' Handheld Remote. 50' Wire Rope, 3/16" Roller Fairlead
SWS4000	4,000lbs 12V DC Winch. 30' Handheld Remote. 60' Wire Rope, 7/32" Roller Fairlead
SWS5000	5,000lbs 12V DC Winch w/ brake. 30' Handheld Remote. 50' Wire Rope, 1/4" Roller fairlead
SW2302287	Plate Mounting for 6000lbs or Higher 6K & 9K
KT4000C	12 VOLT ELECT WINCH 4K CAMO TRAKKER W/15' HAND HELD SWITCH W/LED FLASH LIGHT ROLLER FAIRLEAD
T-02806	ATV WINCH KIT W/STORAGE CASE INCLUDES

 KT4000C	 T-02806	<p>T-02806</p> <p>ATV WINCH KIT W/STORAGE CASE INCLUDES</p> <ul style="list-style-type: none"> 1@ 2X20 5K TOW STRAP W/ 1 HOOK 1 LOOP 1@ 2X6 TREE SAVER 8K MAX 1@ 3/4" 9K BOW SHACKLE 1@ PULLEY BLOCK W/HOOK 8K 1@ 24" CARABINER BUNGEE CORD H/D 1@ NYLON STORAGE BAG FOR MUDDY STRAPS
---	--	--

D
SUPERWINCH

* = Special Order/Non-Stock

Single Speed



Single Speed Winches

Fulton manufactures a full line of single speed winches designed to meet your toughest pulling demands. Our winches feature efficient gear ratios, full-length drum bearings, oil impregnated shaft bushings and our patented "Comfort Grip" handle for ease of cranking. All gears are high carbon steel for superb strength and long-term durability. Stamped carbon steel frames provide rigidity for gear alignment and longer cycle life. Zinc finishes provide excellent corrosion resistance in all environments. All models are designed for use with rope or strap. For end user convenience most models are available with factory installed straps and hooks. Our XL T® Series includes stylized polypropylene shell and strap and hook as standard features. The T1300 and T1500 models offer optional gear covers, for gear train protection, and added styling

D MANUAL WINCHES

MODEL NO.	CAPACITY. LBS	GEAR RATIO	HANDLE LENGTH	MAX. MECH ADV	RATCHET TYPE	DRUM STORAGE ROPE	DRUM STORAGE STRAP	STRAP MFG BOLT SIZE	REPLACEMENT HANDLE
T600	600	3.1:1	6"	34:1	Grabber One Way	36' x 1/4"	15' x 2"	1/4" x 2-1/2" Grade 5	5868
T1602	1600	5.1:1	9"	56:1	Two Way	20' x 7/16"	20' x 2"	3/8" x 2-3/4" Grade 5	6822
XLT1400 Black	1400	4.1:1	8"	43:1	Two Way	N/A	20' x 2"	5/16" x 2-1/2" Grade 5	6302
T1500	1500	4.1:1	8"	49:1	Two Way	20' x 5/16"	20' x 2"	1/4" x 2-1/2" Grade 5	6302
T1500-20 W/20' STRAP & HOOK	1500	4.1:1	8"	49:1	Two Way	20' x 5/16"	20' x 2"	1/4" x 2-1/2" Grade 5	6302
T900	900	3.1:1	7"	39:1	Grabber Two Way	36' x 1/4"	15' x 2"	1/4" x 2-1/2" Grade 5	6312
T1300	1300	4.1:1	8"	49:1	Two Way	30' x 5/16"	20' x 2"	1/4" x 2-1/2" Grade 5	6302
T1801	1800	5.1:1	10"	62:1	Two Way	20' x 7/16"	20' x 2"	3/8" x 2-3/4" Grade 5	6817

- WC325** 4200 lb winch Cable 25'
- WC750** 5600 lb winch cable 50' w/hook
- WR20** Winch rope with hook 20'
- WS20** 2600 lb winch strap 30'
- WS900** 900 lb Zinc winch & stand
- WSP12** Winch strap for personal water craft w/ Loop & Hook 1800 MWL
- T562101** Fulton Winch Cable Keeper Kit



Two Speed

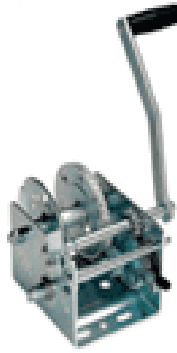

Two Speed Winches

Make lite work of heavy loads with Fulton two-speed winches. One fast speed for quick pull in, a second low speed for increased mechanical advantage. Our shift lock design allows changing gears without moving the crank handle from shaft to shaft. Just lift the shift lock and slide the shaft into the desired gear position. Shift lock holds the shaft in gear. Neutral, free-wheel position, allows quick line payout without spinning the handle. Our ratchet pawl also has a convenient neutral position. Optional handbrake kit No. 1619-01 (Purchased separately except on TXXXXB models) is available for all two-speed winches and can be installed after the winch is mounted.

MODEL NO.	CAPACITY. LBS	GEAR RATIO	MAX. MECH ADV	DRUM STORAGE ROPE	DRUM STORAGE CABLE	DRUM STORAGE STRAP	STRAP MFG BOLT SIZE	HUB SIZE	HAND BRAKE	REPLACEMENT HANDLE
T2005	2000	4.1:1 & 9.8:1	87:1	20' x 7/16"	N/A	20' x 2"	3/8" x 2-3/4" Grade 5	1"	1619-01***	6817
T2605	2600	5.1:1 & 12.2:1	108:1	24' x 7/16"	N/A	20' x 2"	3/8" x 3-1/2" Grade 5	1"	1619-01***	6817
T2625	2600	5.1:1 & 12.2:1	79:1	N/A	175' x 7/32"	N/A	Cable Only	1-3/4"	1619-01***	6817
T3700	3700	5.1:1 & 15.8:1	102:1	N/A	185' x 7/32"	N/A	Cable Only	1-3/4"	Included	9235
T3205	3200	5.1:1 & 12.2:1	79:1	N/A	175' x 7/32"	N/A	Cable Only	1-3/4"	1619-01***	6817

Automatic Brake



Automatic Brake Winches

Fulton's K Series self-activating automatic brake winches hold the load securely when the crank handle is released. Unlike our competitors, no minimum line load is required to activate the brake or payout cable from the winch. Typical applications include boatlifts, grain augers, manual forklifts, retractable swing keels, dumpster lid lifts and manual hoists. Drum hubs are 10X recommended cable size to maximize cable life.

The KX series offer plated gear covers for improved gear train protection, and a dual ratchet system for added load control security.

MODEL NO	MAX LINE PULL 1ST LAYER	MAX LINE PULL FULL DRUM	MAX CABLE DIAMETER	DRUM STORAGE CABLE	GEAR RATIO	DRUM HUB DIAMETER	MAX. MECHANICAL ADVANTAGE	FREE WHEEL
K650B	600 lbs. (272 kg.)	200 lbs. (91 kg.)	1/8" (3.2 mm)	85 ft. (26 m)	1:1	1-1/4" (32 mm)	16:1	No
K2550	2500 lbs. (1134 kg.)	1500 lbs. (680 kg.)	5/16" (8 mm)	70 ft. (21 m)	15.8:1	3-1/8" (79 mm)	64:1	No
K/KX1550	1500 lbs. (680 kg.)	700 lbs. (318 kg.)	1/4" (6 mm)	70 ft. (21 m)	5.1:1	2-1/2" (63 mm)	32:1	No

* = Special Order/Non-Stock



B1001 - 2.5" Round Rubber Bumper

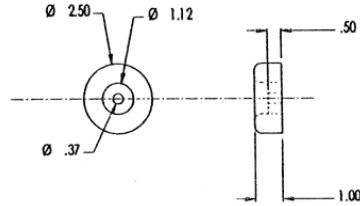

WC1086 - Heavy Duty Wheel Chock
with Chain Eyelet
10" x 6" x 8"

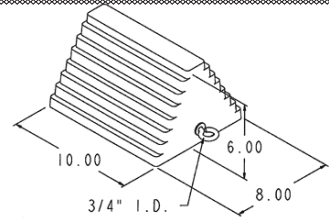

WC9642Y Yellow Composite
Wheel Chock Set w/ Rope,
9-1/2" x 6" x 4"



WC1468 - Rubber
Wheel Chock



WC1467A
Rubber Wheel Chock, 5" x 6" x 5"

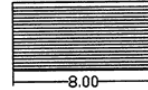

BBP1018 - Poly fender
guard 10"x18" 1/8"
thick Mfg # B1018PPB



MFBH2375A
90 DEG MUD FLAP
MOUNTING PLATE PAIR
WELD ON FITS ALL 24"
FLAPS



MFW2375
MUDFLAP REINFORCEMENT BOLTING PLATE
FOR 24" FLAPS ZINC SOLD IN PAIRS

B1308115
3/4" x 48" Fluorescent Orange
Marker Kit, Bolt-On Base

D
BUMPERS & WHEEL CHOCKS

Dump Body/Trailer TARP KITS

Extruded aluminum cross bars telescope to exact bed width of dumps & trailers up to 102" wide.
 Cast bearings and zinc plated hardware.
 Folding crank handle.
 22' pull rope included.
 Optional rear anti-sail tarp retention bow set.
 All hems reinforced with 2" heavy-duty nylon webbing.
 Heavy-duty double stitching all around the hem.



DTR7015 Shown



DTR6515 Shown

Folding Crank Handle with
Detent LatchAlternate Handle Mounting
Position22 ft. Pull Rope with Clip & Tie
Hooks IncludedOptional Rear Anti-sail Tarp
Retention Bow Set















Note: To help select proper tarp size, tarp width should not exceed outside width of cab shield or bulkhead. Tarp length should generally be 2'-3' longer than body and cab shield length.

Part number	Description	Weight
DTR4510	4-1/2' x 10' Mesh Tarp & Hardware Kit	
DTR5012	5' x 12' Mesh Tarp & Hardware Kit	24.75 lbs.
DTR5514	5-1/2' x 14' Mesh Tarp & Hardware Kit	31.75
DTR5511	5-1/3' x 11-1/2' Mesh Tarp & Hardware Kit	
DTR6014	6' x 14' Mesh Tarp & Hardware Kit	26.75 lbs.
DTR6515	6-1/2' x 15' Mesh Tarp & Hardware Kit (12' Dump Trailers)	29 lbs.
DTR6518	6-1/2' x 18' Mesh Tarp & Hardware Kit (14' Dump Trailers)	28.5 lbs.
DTR7012	7' x 12' Mesh Tarp & Hardware Kit	26.55 lbs.
DTR7015	7' x 15' Mesh Tarp & Hardware Kit (1-Ton & Super D)	32.0 lbs.
DTR7015S	7' x 15' Solid Vinyl Tarp & Hardware Kit (1-Ton & Super Duty Dumps)	34.0 lbs.
DTR7018	7' x 18' Mesh Tarp & Hardware Kit (1-Ton & Super Duty Dumps)	30.25 lbs.
DTR7018S	7' x 18' Solid Vinyl Tarp & Hardware Kit (1-Ton & Super Duty Dumps)	36.0 lbs.
DTR7020	7' x 20' Mesh Tarp & Hardware Kit	34 lbs.
DTR7512	7-1/2' x 12' Mesh Tarp & Hardware Kit	lbs.
DTR7515	7-1/2' x 15' Mesh Tarp & Hardware Kit (Full Size Dumps)	33 lbs.
DTR7515S	7-1/2' x 15' Solid Vinyl Tarp & Hardware Kit (Full Size Dumps)	34 lbs.
DTR7518	7-1/2' x 18' Mesh Tarp & Hardware Kit (Full Size Dumps)	31 lbs.
DTR7520	7-1/2' x 20' Mesh Tarp & Hardware Kit (Full Size Dumps)	36 lbs.
DTR7520S	7-1/2' x 20' Solid Vinyl Tarp & Hardware Kit (Full Size Dumps)	40 lbs.
DTR8022	8' x 22' Mesh Tarp & Hardware Kit	34.5 lbs.
DTR1	Roll Kit (less tarp), for Pre-drilled Rugby Dumps	16.25
DTR	Dump Tarp Roll Kit (less tarp), Universal	16 lbs.
DTB102	Rear Anti-sail Tarp Retention Bow Set, Universal	14 lbs.

* = Special Order/Non-Stock

- * Manufactured with durable, long lasting polyurethane
- * Will not mar boat surface
- * Far superior to rubber rollers in cut & tear resistance, shock absorbtion, and will not flat spot
- * No mounting hardware sold at this time.

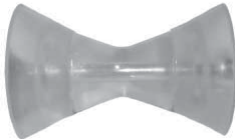
D BOAT ROLLERS & ACCESSORIES

 <p>312B Bent Channel Pad 3" x 12"</p>		 <p>PA3 3" 5/8" Hole PA5 5" Bow Stop Jet Ski Bow Stop</p>
 <p>Jet Ski Bow Stop 4" 5/8" Hole PA4</p>	 <p>Super Jet/ Waverunner Bow Stop 5/8" Hole PA6</p>	 <p>3" V Bow Stop PR3V</p>
 <p>4" Bow Stop PR4V</p>	 <p>Ribbed Wobble Roller 3" x 4" Fits EZ Loader PR36</p>	 <p>Boat Roller Wobble Roller 3/4" Hole PR44</p>
 <p>4" Keel Roller 1/2" Hole 5" Keel Roller 5/8" Hole PR4-5 PR5</p>	 <p>8" Keel Roller 5/8" Hole 10" Keel Roller 5/8" Hole *PR8 *PR10</p>	 <p>12" Keel Roller 5/8" Shaft PR12</p>
 <p>12" Str Roller 5/8" Hole PR212</p>	 <p>Supreme Bow Stop 3" Includes Bolt SBS3</p>	 <p>4" BOW ROLLER 1/2 HOLE PR4B</p>
 <p>Supreme Bow Stop 4" Includes Bolt SBS4</p>	 <p>W8012 BUNK CARPET 12" X 12' BLK</p>	

Protect Your Equipment and Maximize Productivity with the Trailer Caddy Series!



LT30

GAS CAN RACK

- Holds one 5-Gallon or two 2.5-Gallon rectangular polymer cans
- Includes strap to secure can(s)



Quality since 1946



HAND TOOL RACK

- Holds six straight handle tools
- Keeps tools organized and trailer bed clutter free
- Includes rubber grommets to protect tools

LT35

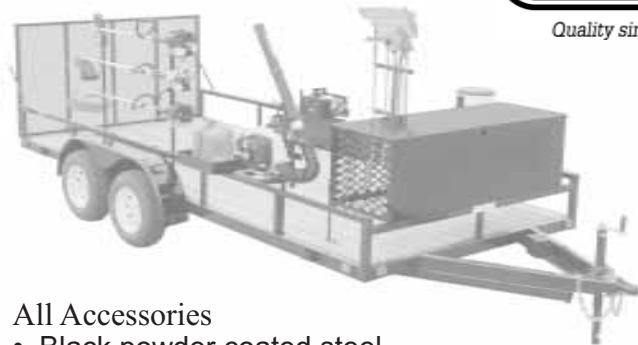

All Accessories

- Black powder coated steel
- Mounting hardware included



LT20

Backpack Blower Rack

- Blowers mount and secure conveniently hook with spring latch
- Includes rubber straps to secure equipment (not for STIHL BR 400 Blower Series)

LT22

BACK PACK BLOWER STIHL BRAND ONLY MOUNT BRKT

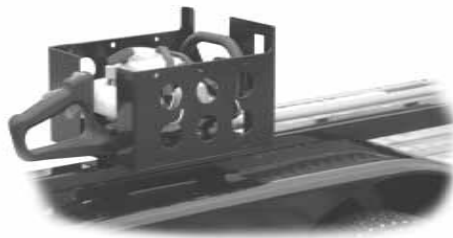

LT15

Multi-Rack

- Protects hedge trimmers, chainsaws or handheld blowers
- Includes rubber straps to secure equipment

LT12

Trimmer Rack, 3-Position Snap-in, Enclosed Trailer

LT13

Lockable Trimmer Rack
Special Order Only

LT25

Water Cooler Rack

- Holds most standard Coolers
- Adjustable straps included



LT25

LT10

LOCKABLE TRIMMER RACK

- Easy snap-in design, one hand operation
- Long-lasting stainless steel springs
- Holds three trimmers
- Vinyl coated hooks
- Secures with padlock (not included)



CC600

Conduit Carrier Kit

Pipe not included carried by hardware stores

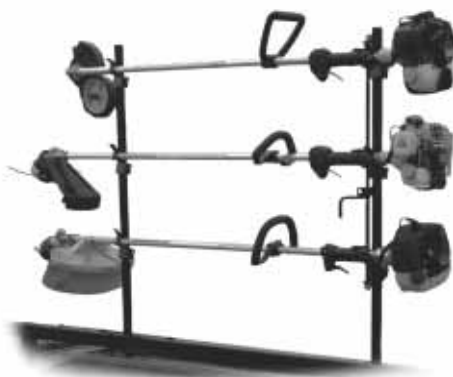

LT10

D LANDSCAPE TRAILER ACCESSORIES

* = Special Order/Non-Stock

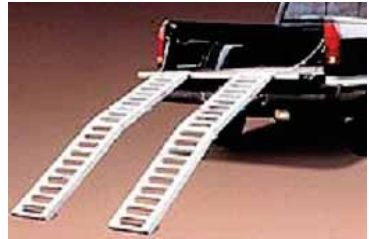

CFR - Single Ramp, Center Fold
12" Wide, 7' Long 700lb Cap
Sold Singly

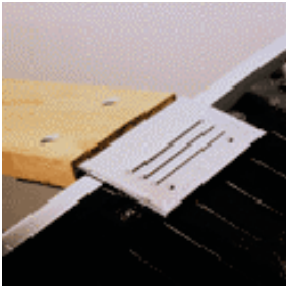

RE8T - Ramp Ends 8" Top Bracket Only
Wood Not Included

RE12T - Ramp Ends 12" Top Bracket Only
Wood Not Included



RE8TB - Ramp Ends 8" Complete
Wood Not Included

RE12TB - Ramp Ends 12" Complete
Wood Not Included



AST460
ANTI SKID TAPE 4" X60'
ROLL SELF ADHESIVE
BLACK COURSE GRIT
INDIVIDUALLY BOXED



T-1120800 30" x 69" Bi-Fold Ramp
Two ramps in one for maximum flexibility.
Adapts to fit loads of larger widths.
Patented self-locking slip hinge allows for safe
use as two 15" wide ramps or one 30" extra wide ramp.



T-1121500 - 1500lbs Tri-Fold Utility Ramp
54" x 77", Folds to 18" 7" Rungs
Full width top plate provides stability and smooth
transition to the truck bed. Extra wide surface for
multiple load sizes.

T-05680 - Rubber Safety Tread
2 PK



D
RAMPS



11200 Ramp Champ
Ramp Champ is the perfect solution to all your loading needs. Heavy duty composite structural technology delivers superior 750-lb. per ramp performance. Telescopes from 5-1/2 feet to nearly 8 feet for greater range of use and ease of storage.
Rustproof for lifetime performance
Impervious to gas and oil
Raised edge keeps tires on ramp
TRAControl non-slip surface for extra traction
Arched design for additional clearance
No hinge point - eliminates any chance of pinching fingers



Part No.	Description
SP1025DBA	DOUBLE BRKT ALUMINUM HANGER USE FOR GOGGLES, TAPE ROLLS, SMALL CORDS, OR EVEN JACKETS . 3.5"H x 10.25"Wx 2.5"D
SP135FLHOA	FLASHLIGHT HOLDER ALUMINUM INSTALL ANYWHERE 5.25"H X 2.75" W X 2.75"D HOLES WITH GROMETS
SP24HR	SS TUBULAR GEAR SHELF 24" 12.6"H x 25.9"L x 16.3"D
SP48HR	SS TUBULAR GEAR SHELF 48" 12.6"H x 49.9"L x 16.3"D
SP25BK	MOUNTING BUTTON 2.5MM KIT SET OF 4 USE WITH ALL TOW-RAX PRODUCT (((((((EXCEPT SP45HFTA TABLE))))))))
SP25SHA	STRAP HANGER 4.5"Hx 17"Wx3"D NO MORE TANGLED STRAPS OR BUNGEE CORDS THIS IS THE PERFECT WAY TO HANG THEM SOLD EACH
SP280HSA	DOUBLE SHELF SIDE BY SIDE ALUMINUM FOR HELMETS,BOOTS OR CLOTHES. 10.5"H x 28"W x 15"D HANGER BAR UNDERNEATH CAN BE REMOVED
SP2BRA	DUAL JUG RACK ALUMINUM 12"H x25"W x 12.5"D SAFELY HOLD 2 PROPANE OR FUEL JUGS FROM SLIDING AROUND
SP2CH	CUP OR CAN HOLDER ALUMINUM HOLDS 2
SP30ATC	TOOL CABINET W/ FOLD DOWN TRAY 30"Hx25.5"Wx3"D PLACES FOR SCREW DRIVERS,PLIERS, WRENCHES,
SP30CDS	STORAGE CABINET W/FOLD DOWN TRAY STAINLESS STEEL MIRROR POLISHED BACK 3 SHELF + PAPER TOWEL HOLDER THAT IS SPRING LOADED TO PREVENT UNROLLING 30"Hx25.5"Wx9"D
SP35SBA	SINGLE BRKT ALUMINUM HANGER FOR ODDS AND INS 3.5"H X 3.5"W X 2.5"D
SP36CCA	COMBO CABINET 3 SHELF UNIT 36"Hx25.5"Wx9"D STORE ALL YOUR FLUIDS
SP45HFTA	FOLDING TABLE TOP 45"L X 18"WX3"D SET APROX 4" FROM WALL WHEN FOLDED DOWN, WORKING CAPACITY IS 100lbs.
SP30BK	MOUNTING BUTTONS FOR SP45HFTA ONLY 3MM SET OF 4 BUTTONS SO YOU CAN MOVE YOUR FOLDING TABLE ANYWHERE YOU CAN MOUNT IT !!!!
SP50CKA	CHANNEL KIT ALUMINUM 50"L x 3.25"W x .75"D SOLD AS SET OF 2
SP8SHA	STRAP HANGER 4.5"Hx 8"Wx3"D NO MORE TANGLED STRAPS OR BUNGEE CORDS
SPKPB	PUNCH KEY BRKT KIT W/BUTTONS 2"H X 2"W X 1"D MAKE YOUR FAVORITE TOW RAX CABINET MOVABLE FOR CABINETS NOT ALREADY EQUIPED W/BUTTON SYSTEM

D PHOENIX TOW RAX



* = Special Order/Non-Stock



SPCHH



SPJCA

Part No.	Description
SPCHH	CORNER HELMET SHELF ALUMINUM 21"H x14.25"W x 15.75"D STORE 2 HELMETS & PLACES TO HANG ITEMS ALSO
SPHHA	HELMET HOOK SINGLE 6" LONG ALUMINUM BRKT 4" X 4" BASE
SPJCA	JR. STORAGE CABINET W/FOLD DOWN WORK TRAY KEY HOLE BUTTON MOUNT, 2 KITS INCLUDED ,FOR MOUNTING IN MULTIPLE LOCATIONS
SPPTH	TOWEL ROLL HOLDER ALUMINUM SPRING LOADED HOLDS 1 ROLL
SPSCBA	CORD & HOSE HANGER ALUMINUM 5.9"H x4"Wx4"D HOLDS MOST CORDS UP TO 100'



SPSCBA



SPPTH



SPWC
SPWS

SPWC	WHEEL CHOCK CHROME STEEL TUBULAR W/ KEYHOLE SLOTS INCL SPWFKW FOR WOOD FLOOR . HOLDS UPTO 6.5" W TIRES MOUNTING KIT IS AVAILABLE FOR METAL FLOORS SEE PART NUMBER SPWFKM SOLD SEPERATE
SPWS	WHEEL CHOCK STAINLESS STEEL TUBULAR W/KEYHOLES-LOTS INCL SPWFKW FOR WOOD FLOOR . HOLDS UPTO 6.5" W TIRES MOUNTING KIT IS AVAILABLE FOR METAL FLOORS-SEE PART NUMBER SPWFKM SOLD SEPERATE
SPWFKM	METAL FLOOR MOUNT HARDWARE



SPWFKM

D

PHOENIX TOW RAX



ST93



LR1



47556-11



49363-10-72



SPPGF

Fits all pickup trucks. Also ideal for trailers, vans, utility vehicles, boats, etc.
 Load rings may be positioned every two inches.
 Set includes four 46-1/2" long clear anodized aluminum rails, pre-drilled for easy installation.
 Includes eight adjustable load rings (additional load rings available, part no. LR1).

Capacity:
 1,200 lbs. Min. Break Strength
 400 lbs. Working Load Limit

Mounting hardware included.

ST93	SUPER TRACK ALUMINUM SET OF 4 46.5" X 1 1/8" INCLUDES 8 ADJ LOAD RINGS (LR1) 1200 lbs BS 400 lbs wll. with mounting hardware
LR1	BUYERS LOAD RING FOR SUPER TRACK
47556-11	LOAD RINGS DUAL CATCH
49363-10-72	TOW RAX FLOOR TRACK 72" x 2" Alum.
SPPGF	FLOOR TRACK END CAP SOLD EACH (Track sold sepearte)

D
 FLOOR TRACKS