

Cargo Control

- Bike Pads
- Bungees
- Camper Tie Downs, Torklift
- Cargo Pods
- Hitch Carriers
- Load Bars
- Motor Cycle Carriers
- Nets
- Paddle Latches
- Roof Racks
- Straps
- Tie Downs
- Toolboxes
- Bumper Accessories & Mudflaps
- Locks
- Mirrors
- Motor Cycle & ATV Covers
- Receiver Covers & Accessories
- Spare Covers
- Suspension Enhancement
- Accessories & Shelves
- Boxes & Tanks
- Motor Cycle Pads
- Racks & Landscape Accessories
- Steps & Handles
- Anchors
- Binders
- Chain, Cables & Links
- Door Hlders, Latches & Hitches
- D-Rings
- E-Track
- Hooks
- Pins
- Truck Winches, Straps & Track
- Room Actuators
- Stakes, Pockets & Slats
- Boat Rollers & Accessories
- Boat Anchors
- Boat Bunks & Guides
- Jet Rail
- Tie Down Boat Rollers & Accessories
- Roof Vents
- RV & AC Covers
- Tank Covers
- Tarps/ Roll Tarps
- Winches & Accessories

Cargo Control

Bed Covers

RETRAX™

The Last Bed Cover You'll Buy

Meeting Your Leisure, Professional & Upscale Needs

- ✓ **Warranty** – Best on retractable covers in the market
- ✓ **Secure** – Latches and Key lockable in any position
- ✓ **Durable** – Retracts without wear and tear in unique spiral track canister that prevents cover from coming in contact with itself
- ✓ **Stylish** – Unique low profile design
- ✓ **Flexible** – Unlimited hauling flexibility

Available with Realtree® Camo



- ✓ **Precision** – Sealed-for-life bearings for smooth, one-handed operation

2014 RETRAX APPLICATIONS

Ideal for Automotive Family Groups

STYLE*	RETRAX ONE	RETRAX CAMO	RETRAX PRO	POWERTRAX ONE	POWERTRAX CAMO	POWERTRAX PRO
Ford / Lincoln	19	8	17	8	8	8
Chevy / GMC	24	12	22	12	12	12
Dodge	15	5	15	5	5	5
Toyota	14	7	12	7	7	7

* 52 Additional applications for Nissan, Honda, Mitsubishi, Mazda, Isuzu, and Suzuki



RETRAX ONE

Tempered aluminum support beams embedded into the polycarbonate sheet add strength to support heavy snow loads and ensure quiet, stable travel at any speed. Ideal for 5th wheels.



RETRAX PRO

Industrial strength aluminum provides support to distributed loads of more than 500 pounds! Ideal investment for heavy duty uses.



POWERTRAX ONE

If luxury is the name of your game, you'll appreciate the PowertraxONE - opens and closes with the touch of a button from a remote keyfob.



POWERTRAX PRO

This **AWARD WINNING** retractable bed cover features all the same great benefits of the RetraxPRO, but allows for hands-off operation via a wireless remote control.

2013 Top Sellers by Product Numbers: Complete with designated rails

Year	Make & Model	Options	Bed Size	Product Number	Year	Make & Model	Options	Bed Size	Product Number
09-up	Ford F-150 Super Crew / Cab		5'5"	10371	07-13	Chevy-GMC	Wide Rail System	5'8"	10431
09-up	PRO-Ford F150 Super Crew/Cab		5'5"	40371	99-up	PRO-Ford Super Duty 250-450		Long	40323
08-up	Ford Super Duty F-250 & F-350		Short	10362	09-up	PRO - Ford-150 Super Crew/Cab; Reg Cab		6'5"	40371
09-up	Ford F-150 Super Crew/Cab, Reg Cab		6'5"	10372	07-13	Chevy - GMC	Wide Rail System	6'5"	10432
07-up	Chevy Silverado / GMC Sierra		5'8"	10421	09-up; 10-up	PRO - Ram 1500; 2500-3500		6'5"; Short	40232
09-up	Dodge Ram 1500/10-up 2500/3500		6'4"	10232	06-up	Honda Ridgeline			10501
09-up	Dodge Ram 1500	Not RamBox	5'7"	10231	09-up	PRO - Ram 1500	Not Ram Box	5'7"	40231
07-13	Chevy Silverado/ GMC Sierra		6'5"	10422	07-up	Tundra Crew Max		5'5"	10831
08-up	PRO - Ford Super Duty 250 & 350 - Short Bed		Short	40362	07-up	Tundra Crew Max	w/ Deck Rail System	5'5"	10841
14-up	Chevy - GMC		5'8"	10461	14-up	Chevy - GMC		6'5"	10462
09-up	PTONE - Ford-150 Super Crew/Cab		5'5"	20371					

Cargo Control & Accessories

Cargo Control

Bike Racks

A: Receiver Size B: Mfg.

Item Number	Description	Color	SO	A	B
CU18013	3-Bike Clamp-On Rack	Black		2in	Curt
CU18016	Bike Beam 22-1/2in to 31in	Black		N/A	Curt
CU18019	4-Bike Folding Rack Single Arm	Black		2in	Curt
CU18019-05	4-Bike Folding Rack Single Arm	Drk Blue	Yes	2in	Curt
CU18019-10	4-Bike Folding Rack Single Arm	Yellow	Yes	2in	Curt
CU18027	4-Bike Towable Rack-WSL	Gray		2in	Curt
CU18029	2-Bike Folding Rack Dual Arm	Black		1-1/4-2in	Curt
CU18030	2 or 4-Bike Folding Rack Dual Arm	Black		1-1/4-2in	Curt
CU18033	3-Bike Folding Rack Dual Arm	Black		1-1/4-2in	Curt
CU18034	4-Bike Folding Rack Dual Arm	Black		1-1/4-2in	Curt
CU18050	Bike Rack Strap w/Cambuckle	Black		N/A	Curt
CU18063	3-Bike Folding Rack Dual Arm	Black		2in	Curt
CU18064	4-Bike Folding Rack Dual Arm	Black		2in	Curt
CU18065	5-Bike Folding Rack Dual Arm	Black		2in	Curt
TH822	2-Bike Bed Rider Rack	Black	Yes	N/A	Thule

Cargo Control

Bike Racks

1 1/4" & 2" HITCH-MOUNTED TRAY-STYLE BIKE RACKS

- Tilts away for rear vehicle access
- Adjustable arms for various bike heights and styles
- Compact storage - sides fold up when not in use
- Anti-wobble shank
- Do not install on a trailer or other towed vehicle
- Durable powder coat finish



Pkg#	# of Bikes	Max Load	Tilt	Shank Size	Description
18084 NEW	2	90 lbs.	Yes	1 1/4" x 1 1/4"	2-bike bike rack
18086 NEW	4	180 lbs.	Yes	2" x 2"	Extendable 4-bike bike rack

NEW



Easily adjusts for various bike styles



Tilts away for rear vehicle access



Threaded shank prevents wobble



Padded arms adjust for varying bike sizes



Compact storage, sides fold up

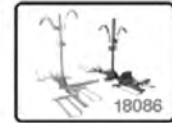

Removable 2-bike extension



18084 Packaged

2" CLAMP-ON BIKE RACK

- Clamps onto a 2" x 2" ball mount shank
- Adjustable rubber cradles will not scratch bike frame
- Support straps included
- Easily accessible release handle
- Do not install on a trailer or other towed vehicle
- Durable powder coat finish



Easily accessible release handle



Fits 2" x 2" ball mount shank



18013 Packaged



18013

Pkg#	# of Bikes	Max Load	Tilt	Description
18013	3	135 lbs.	No	3-bike clamp-on bike rack

Cargo Control

Bike Racks

1 1/4 INCH & 2 INCH HITCH-MOUNTED BIKE RACKS

- Tilts away for rear vehicle access
- Adjustable rubber cradles will not scratch bike frame
- Arms fold down when not in use
- Support strap included
- Compact package makes part#s 18029 and 18030 retail-friendly
- Anti-wobble shank
- Do not install on a trailer or other towed vehicle
- Durable powder coat finish



Pkg#	# of Bikes	Max Load	Tilt	Shank Size	Description
18029	2	90 lbs.	Yes	1 1/4" x 1 1/4" and 2" x 2"	2-bike bike rack
18030	2 or 4	90 / 180 lbs.	Yes	1 1/4" x 1 1/4" and 2" x 2"	Extendable 2 or 4-bike bike rack
18033	3	135 lbs.	Yes	1 1/4" x 1 1/4" and 2" x 2"	3-bike bike rack
18034	4	180 lbs.	Yes	1 1/4" x 1 1/4" and 2" x 2"	4-bike bike rack



18030
Removable arm extenders save space



Tilts away for rear vehicle access



Threaded shank prevents wobble



Support strap included



Adjustable rubber cradle



18029 & 18030
Bolt-together post for compact packaging



18029 Packaged, easily fits on the shelf



18030 Packaged, easily fits on the shelf

2 INCH HITCH-MOUNTED PREMIUM BIKE RACKS

- Tilts away for rear vehicle access
- Tapered arms for easy mounting of smaller bikes
- Built-in reflectors
- Adjustable rubber cradles will not scratch bike frame
- Arms fold down when not in use
- Anti-wobble base
- Do not install on a trailer or other towed vehicle
- Durable powder coat finish



18064 Packaged



Pkg#	# of Bikes	Max Load	Tilt	Shank Size	Description
18063	3	135 lbs.	Yes	2" x 2"	Premium 3-bike bike rack
18064	4	180 lbs.	Yes	2" x 2"	Premium 4-bike bike rack
18065	5	225 lbs.	Yes	2" x 2"	Premium 5-bike bike rack



Tilts away for rear vehicle access



Threaded shank prevents wobble

Cargo Control

Bike Racks

A: Receiver Size

2 INCH SINGLE-ARM BIKE RACK

- Tilts away for rear vehicle access
- Rubber lined cradles will not scratch bike frame
- Lockable
- Do not install on a trailer or other towed vehicle
- Durable powder coat finish
- **Limited lifetime warranty**



Tilts away for rear vehicle access



Accepts bike frames up to 1 1/4" diameter



Pkg#	# of Bikes	Max Load	Tilt	Shank Size	Description
18019	4	150 lbs.	Yes	2" x 2"	Single-arm 4-bike bike rack

BOLT-ON BIKE RACK

- Tilts away for rear vehicle access
- Bolts on to any ball mount or step bumper with a 3/4" hole (ball mount not included)
- Accepts up to two bikes
- Coated arms will not scratch bike frame
- Do not install on a trailer or other towed vehicle



Lockable arms

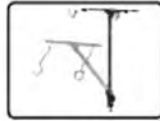

Tilts away for rear vehicle access



Pkg#	# of Bikes	Max Load	Hole Size	Tilt	Description
18011	2	70 lbs.	3/4"	Yes	Bolt-on 2-bike bike rack

BIKE RACK ACCESSORIES

- Great add-on items
- Support strap recommended for all hitch-mounted bike racks
- 18016 allows bike rack use with angled frame bicycles



23666



18050

18016

Pkg#	Length	Description
18016	Extends from 22 1/2" to 31"	Adjustable bike beam for carrying various bike frames
23666	6'	Heavy duty security cable
18050	1" wide by 61" long	Bike rack support strap

ANTI-RATTLE KITS

- Use with part# 18019, CURT cargo carriers and hollow shank accessories
- Stops rattling and prevents swaying of load when using hollow-shank towing accessories
- Attractive, full-color, retail clamshell packaging



22315

22321

23590

Pkg#	Tube Size	Lock Diameter	Finish
22315	1 1/4"	--	Yellow zinc
22321	2"	--	Yellow zinc
23590	2"	5/8" with M16-2.0 threads	Zinc

Cargo Control

Bungees

A: Length B: Mfg.

Item Number	Description	SO	A	B
06724	Adjustable Tarp Strap-6pk	Yes	24in	Erickson
687660	Bungee Assortment		Multiple	USA
687800	Bungee Assortment		Multiple	USA
714120	Tarp Strap w/S Hook-2Pk	Yes	41in	USA
TS15	Rubber Bungee Tarp Strap		15in	Tuff-Tow
TS20	Rubber Bungee Tarp Strap		21in	Tuff-Tow
TS31	Rubber Bungee Tarp Strap		31in	Tuff-Tow
TS9	Rubber Bungee Tarp Strap		9in	Tuff-Tow



Camper Tie Downs, Torklift



Item Number	Description	SO
TLM8008	Turnbuckle Inserts-Ea.	
TLS9000	Basic Spring Load Turnbuckles 24in-45in (2)	
TLS9011	Eye to Eye Turnbuckle HD (1)	Yes
TLS9013	Anchorguards Turnbuckles (4)	
TLS9020	Derringer Anchorguards Turnbuckles (4)	
TLS9050	XI Spring Load Turnbuckles (2)	
TLS9500	Fastgun Lock Set Keyed A-Like (4)	
TLS9520	Fastgun Turnbuckles Grey 14in-21in (2)	
TLS9522	Fastgun Turnbuckles Grey 25in-43in (2)	
TLS9523	Fastgun Turnbuckles White 25in-43in (2)	
TLS9526	Fastgun Turnbuckles Polished 25in-43in (2)	
TLS9527	Fastgun Turnbuckles Polished 14in-21in (2)	
TLS9528	Fastgun Derringer Quick Disconnect Polished (4)	

Cargo Control & Accessories

Cargo Control

Hitch Carriers

A: Length B: Width C: Height D: Receiver E: Load Capacity F: Mfg.

Item Number	Description	A	B	C	D	E	F
CU18100	Cargo Carrier Alum 2-Piece Fold Up	60in	20in	2-3/4in	2in	500lbs	Curt
CU18101	Cargo Carrier Universal ATV	41in	26in	6-1/4in	N/A	N/A	Curt
CU18120	Cargo Carrier 2-Piece	60in	20in	2-3/4in	2in	500lbs	Curt
CU18121	Cargo Carrier 2-Piece Fold Up	60in	20in	2-3/4in	2in	500lbs	Curt
CU18130	Cargo Carrier Basket 2-Piece	60in	20in	6in	2in	500lbs	Curt
CU18131	Cargo Carrier Basket 2-Piece Fold Up	60in	20in	6in	2in	500lbs	Curt
CU18132	Cargo Carrier Basket 2-Piece Fold Up	60in	24in	6in	2in	500lbs	Curt
CU18133	Cargo Carrier Basket 2-Piece	60in	24in	6in	2in	500lbs	Curt
CU18140	Cargo Carrier 2-Piece Raised Shank	60in	20in	2-3/4in	1-1/4in	300lbs	Curt
CU18145	Cargo Carrier Basket 2-Piece w/Sleeve	48in	20in	6in	1-1/4	500lbs	Curt
CU18202	Cargo Carrier Net For 60in Wide	43in	24in	N/A	N/A	N/A	Curt

UNIVERSAL ATV CARGO CARRIER

- Includes mounting hardware
- Attractive, full-color retail packaging



18101



18101
Packaged



Pkg#	Capacity	Finish	Dimensions
18101	Limited to ATV	Carbide	41" x 26" x 6 1/4"

See next page for more images.

Cargo Control

Hitch Carriers

1 1/4 & **2** INCH **CARGO CARRIERS**

• Attractive, full-color retail packaging



Pkg#	Capacity	Shank Size	Dimensions	Shank	Finish	Description
18100*	500 lbs.	2" x 2"	60" x 20" x 2 3/4"	Folding	Light-weight aluminum	Bolt-together carrier
18108 NEW	500 lbs.	2" x 2"	60" x 20" x 2 3/4"	Fixed	Carbide	Bolt-together carrier
18109* NEW	500 lbs.	2" x 2"	60" x 20" x 2 3/4"	Folding	Carbide	Bolt-together carrier
18110 NEW	300 lbs.	1 1/4" x 1 1/4"	48" x 20" x 2 3/4"	Fixed	Carbide	Bolt-together carrier with 2" adjustment increments

* Rear-mounted spare tires may interfere with the folding feature

1 1/4 & **2** INCH **BASKET STYLE CARGO CARRIERS**

• Heavy duty, tubular, steel construction
• 6" tall sides for added security
• Compact package makes part# 18145 retail-friendly



Pkg#	Capacity	Shank Size	Dimensions	Shank	Finish	Description
18150 NEW	500 lbs.	2" x 2"	60" x 20" x 6"	Fixed	Carbide	Bolt-together basket carrier
18151* NEW	500 lbs.	2" x 2"	60" x 20" x 6"	Folding	Carbide	Bolt-together basket carrier
18152 NEW	500 lbs.	2" x 2"	60" x 24" x 6"	Fixed	Carbide	Bolt-together basket carrier
18153* NEW	500 lbs.	2" x 2"	60" x 24" x 6"	Folding	Carbide	Bolt-together basket carrier
18145	500 lbs.	1 1/4" x 1 1/4" 2" x 2"	48" x 20" x 6"	Fixed	Carbide	Bolt-together basket carrier with adapter sleeve*

* Rear-mounted spare tires may interfere with the folding feature

Cargo Control & Accessories

Cargo Control

Load Bars



A: Min Length B: Max Length C: Mfg.

Item Number	Description	SO	A	B	C
10125-31	Handle Rack Housing w/Nut Bolt	Yes	----	----	Kinedyne
1818-1	Series F Square Shoring Bar	Yes	81in	----	Kinedyne
1818-2	Series F Square Shoring Bar	Yes	94in	----	Kinedyne
900902	Cargo Bar Twist 'n Lock		40in	74in	USA
JB101XL	Square Bar Jack	Yes	86in	114in	Kinedyne

Cargo Control

Ramps

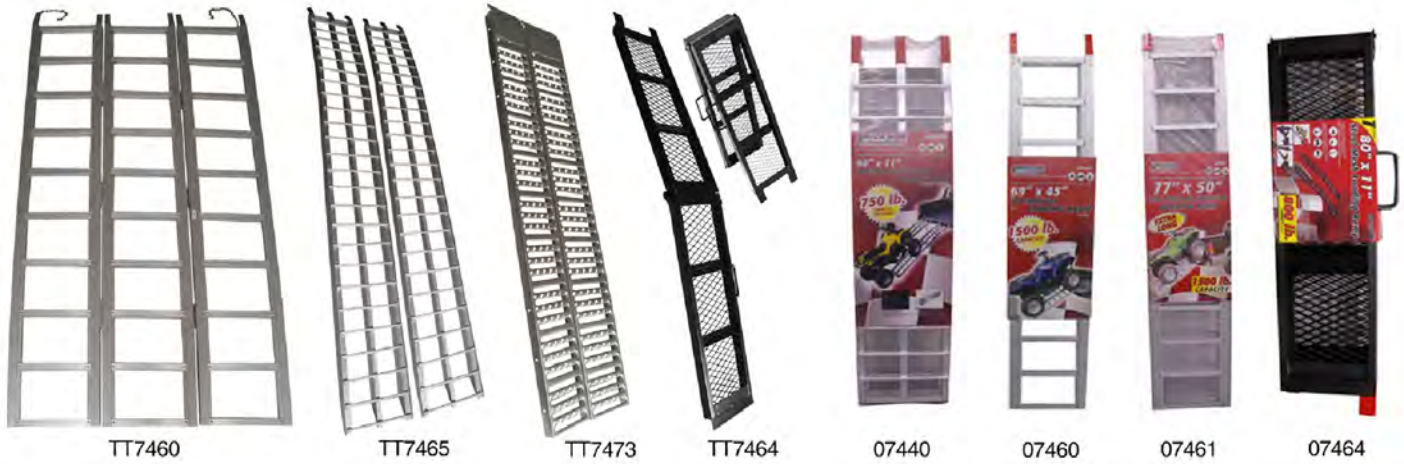

Item Number	Description
07440	Arched Bi-fold Aluminum Ramp 11in x 90in
07460	Tri-fold Aluminum Ramp 45in x 69in
07461	Tri-fold Aluminum Ramp 50in x 70in
07464	Center-fold Steel Mesh Ramp 11in x 80in
07473	ATV/Motorcycle Steel Ramp 9in x 84in
TT7460	Tri-fold Aluminum Ramp 50in x 77in
TT7464	Folding Steel Ramp 11in x 78in
TT7465	Arched Aluminum Ramp 12in x 84in
TT7473	Steel Ramp-Pair 9in x 72in

Ramp Ends

Item Number	Description
07100	Aluminum Ramp Plate 1/8in
07200	Aluminum Ramp Plate 1/4in
07400	Aluminum Ramp Plate 1/4in-2pk



Cargo Control

Motor Cycle Carriers

A: Width B: Capacity C: Mfg.



AA1128-1



SC2001

Item Number	Description	SO	A	B	C
AA1128-1	Motorcycle Carrier w/Ramp		2in	500lbs	Tuff-Tow
SC2000	Motorcycle Carrier	Yes	86in	1000lbs	Blue Ox
SC2001	Motorcycle Carrier II	Yes	78in	600lbs	Blue Ox
SC2100	Sports Carrier	Yes	84in	1000lbs	Blue Ox
SC2101	5th Wheel Motorcycle Carrier	Yes	----	----	Blue Ox
SC3001	Sports Loader Carrier	Yes	86in	1000lbs	Blue Ox
SC4200	Overbuilt Sport Lift III	Yes	3in	1000lbs	Blue Ox
SC9000	Sports Carrier Receiver Hitch	Yes	49in	1000lbs	Blue Ox
SC9001	Tire Support	Yes	5-1/2in	N/A	Blue Ox

Cargo Nets

A: Mfg.



901400



CU18200 & CU18201

Item Number	Description	A
901400	Cargo Net w/Adjustable Hooks	USA
CU18200	Roof Rack Cargo Net 44inx38in	Curt
CU18201	Roof Rack Cargo Net 65inx38in	Curt

Roof Racks



CU18115



CU18117

A: Mfg.

Item Number	Description	SO	A
CU18115	Roof Cargo Rack 41-1/2x37x4		Curt
CU18117	Roof Cargo Rack Extension 21x37x4		Curt

Straps

Tow Straps

A: Length B: Width C: WLL Capacity D: Mfg.



T-04223



T22AS



T3012YDR



10091



T3012YFR



T3012YSW



T8TWS

Item Number	Description	SO	A	B	C	D
10091	Hand Held Strap Winder		N/A	N/A	N/A	Kinedyne
RR1163	Axle Strap	Yes	----	----	----	Firestone
T-04223	Strap w/D-Rings		24in	1-3/4in	1666lbs	Tuff Tow
T22AS	Strap w/D-Rings		24in	2in	3300lbs	Tuff-Tow
T3012YDR	Truck Strap w/Delta Ring		30ft	4in	5400lbs	Kinedyne
T3012YFH	Truck Strap w/Flat Hook		30ft	4in	5400lbs	Kinedyne
T3012YSW	Truck Strap w/Sewn Eye		30ft	4in	5000lbs	Kinedyne
T8TWS	Replacement Strap	Yes	8ft	2in	2000lbs	Tuff-Tow

Cargo Control

Tie Downs



T-05506



T-04110



T-04623



T-272FB



T-04622

A: Length B: Width C: WLL Capacity D: Mfg.

Item Number	Description	Color	SO	A	B	C	D
198010	Top Loader Tie Down	Black		8ft	1-1/2in	500lbs	USA
309710	Ratchet Tie Down	Blue		13ft	1in	300lbs	USA
310701	Ratchet Tie Down	Yellow		27ft	2in	3333lbs	USA
312640	Ratchet Tie Down	Blue		14ft	1in	400lbs	USA
31302	Retractable Ratchet Strap-2pk	Red		10ft	1in	1200lbs	Erickson
315680	Ratchet Tie Down	Yellow		15ft	1in	500lbs	USA
318480	Ratchet Tie Down	Blue		6ft	1in	600lbs	USA
330410	Ratchet Strap	Black		4ft	1-7/8in	1000lbs	USA
340700	Ratchet Tie Down	Yellow		15ft	1-1/2in	1333lbs	USA
34415	Retractable Tie Down-2pk	Black		10ft	1in	1200lbs	Erickson
34416	Retractable Tie Down-2pk	Black		10ft	2in	3300lbs	Erickson
402400	Rope Lock Tie Down	Black		8ft	1/4in	150lbs.	USA
404400	Rope Lock Tie Down	Black		8ft	3/8in	350lbs	USA
409690	Cambuckle Tie Down	Blue		15ft	1in	300lbs	USA
412420	Cambuckle Tie Down	Red		6ft	1in	400lbs	USA
412440	Cambuckle Tie Down	Blue		6ft	1in	300lbs	USA
430400	Cambuckle Tie Down	Yellow		7ft	2in	1100lbs	USA
430600	Cambuckle Tie Down	Yellow		16ft	2in	1100lbs	USA
510884	Ratchet Strap w/Hook Ends	----	Yes	8ft	----	----	Kinedyne
511284	Ratchet Strap w/Hook Ends	----	Yes	12ft	----	----	Kinedyne
CU83049	Ratchet Strap w/J-Hook	Yellow		27ft	2in	3333lbs	Curt
CU83050	Ratchet Strap w/Flat Hook	Yellow		27ft	2in	3333lbs	Curt
CU83053	Ratchet Strap w/J-Hooks	Blue		15ft	1in	1K	Curt
T-04110	Ratchet Tie Down w/Snap Hook 6K	Yellow		10ft	2in	2000lbs	Tuff Tow
T-04622	Ratchet Tie Down w/J Hook 10K	Yellow		27ft	2in	3333lbs	Keeper
T-04623	Ratchet Tie Down w/Flat Hook 10K	Yellow		27ft	2in	3330lbs	Keeper
T-05506	Ratchet Tie Down w/S hook-4pk	Yellow		15ft	1in	500lbs	Keeper
T-222520	Replacement Strap	Yellow	Yes	25ft	2in	3330lbs	Kinedyne
T-272FB	Ratchet Strap	Yellow		27ft	2in	3330lbs	Kinedyne

Cargo Control

Paddle Latches Paddle Latch & T-Handle

A: Mfg.



Item Number	Description	Color	A
7022697	Toolbox Lock Latch Retro-Fit GM Late Model	Stainless	BOLT
7022698	Toolbox Lock Latch Retro-Fit Ford	Stainless	BOLT
7022699	Toolbox Lock Latch Retro-Fit Dodge	Stainless	BOLT
B04025	Paddle Latch Jr Hole Mnt 2-3/4x3-3/4in Pkg	Stainless	Buyers
B04035	Paddle Latch Std Hole Mnt 3-3/8x4-5/8in Pkg	Stainless	Buyers
BL2392	T-Locking Handle	Chrome	Buyers
BL2394	L-Locking Handle	Chrome	Buyers
L3885	Paddle Latch Std Hole Mnt 3-3/8x4-5/8in	Stainless	Buyers
L38RLSCH545	Cylinder & Keys for L3885RLS Latch	Stainless	Buyers
L8815	Folding T-Handle Std Hole Mnt 3-3/4x4in	Stainless	Buyers
L8815GO	Gasket for L8815, L8855, L8915	Black	Buyers
L8816	Folding T-Handle Lg Stud Mnt 4-3/8x3-1/2in	Stainless	Buyers
L8855	Folding T-Handle Std Stud Mnt 3-3/4x4in	Stainless	Buyers
N1883	Paddle Latch Jr No Lock Hole Mnt 2-3/4x3-3/4in	Stainless	Buyers

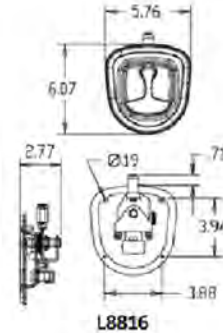
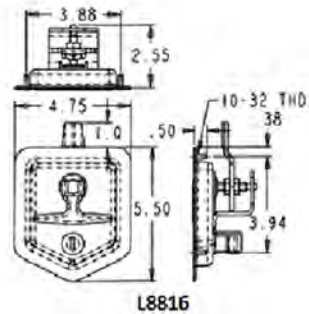
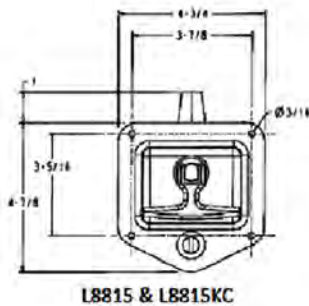

Tool Boxes Tool Box Accessories Conduit Carrier



A: Mfg.

Item Number	Description	SO	A
3006473	CC600 Bracket Saddles Kit	Yes	Buyers
3006474	CC600 U-Bolt Kit	Yes	Buyers
CC600	Conduit Carrier Kit-PVC Not Included		Buyers

Cargo Control

Tool Boxes Tool Box Accessories Fuel Transfer



TFA005715
TFA005715L



TP-9



U5L6FE

A: Mfg.

Item Number	Description	SO	A
TAF0001	Filler Breather Weld Flange Steel Adaptor	Yes	Buyers
TFA005715	Filler-Strainer Breather Cap Assembly	Yes	Buyers
TFA005715L	Filler-Strainer Breather Cap Assembly w/Locking Tab	Yes	Buyers
TP-9	Pump Transfer Hand Spout Style	Yes	Tuff-Tow
U5L6FE	25 Micron Element for HFA5-Series	Yes	Buyers

Hydraulic



PU303LRS



SMR37S

A: Length 1 B: Length 2 C: Depth D: Height E: Mfg.

Item Number	Description	SO	A	B	C	D	E	Extra Info
PU303LRS	Power Unit w/8ft Cord	Yes	21in	N/A	7-1/4in	6-1/4in	Buyers	3 Gal Reservoir
SMR37S	Hydraulic Reservoir w/Site Level	Yes	N/A	N/A	N/A	N/A	Buyers	37 Gal

Cargo Control

Tool Boxes Tool Box Accessories



A: Height B: Depth C: Width D: Mfg.

Item Number	Description	Color	SO	A	B	C	D
3003081	Door Lanyard PVC Coated	Clear		N/A	N/A	17-9/64in	Buyers
3005943	Toolbox Gasket	---		N/A	N/A	60in	Buyers
5411005	Cabinet Mounting Brackets	White		---	---	---	Buyers
5411008	Cabinet w/8 Drawers	White	Yes	8-1/4in	11-3/4in	22-1/8in	Buyers
B1701000	Underbody Brackets for 24in/36in Poly Toolbox	Black	Yes	15in	---	14in	Buyers
B1701005	Underbody Brackets Weld On Steel Toolbox	Black		18in	18in	N/A	Buyers
B1701005B	Underbody Brackets Bolt On Steel Toolbox	Black		18in	18in	N/A	Buyers
B1701006	Underbody Brackets Weld On Steel Toolbox	Black		18in	18in	N/A	Buyers
B1701010B	Underbody Brackets Bolt On Steel Toolbox	Black		18in	24in	N/A	Buyers
B1701015	Underbody Brackets Weld On Steel Toolbox	Black	Yes	24in	24in	N/A	Buyers
B1702115DOOR	Toolbox Door	Black	Yes	18in	18in	60in	Buyers
B1702300DOOR	Toolbox Door	Black	Yes	18in	18in	24in	Buyers
B1702315DOOR	Toolbox Door w/T-handles	Black	Yes	18in	18in	60in	Buyers
B1702325DOOR	Toolbox Door	Black	Yes	18in	18in	34in	Buyers
B1702705DOOR	Toolbox Door	Stainless	Yes	18in	18in	36in	Buyers
B1702840TRAY	Toolbox Tray	White		4in	10-1/2in	35in	Buyers
B1702850TRAY	Toolbox Tray	White		4in	10-1/2in	43in	Buyers
B1702860TRAY	Toolbox Tray	White		4in	10-3/4in	47in	Buyers
B1708310DOOR	Toolbox Door	Black	Yes	18in	24in	48in	Buyers
TBPO01	Side Mount Tool Box Bracket Steel	Black		24in	6in	6in	Phoenix

Cargo Control

Tool Boxes Topside Tool Boxes



A: Height B: Depth C: Width D: Mfg.

Item Number	Description	Color	SO	A	B	C	D
103-VT	Vertical Tank 103 Gal	Aluminum DP	Yes	46-1/2in	24in	22in	Tuff-Tow
10577	Tool Box & Fuel FT-30	Black	Yes	14in	18-3/4in	48in	Handy
B1701561	Topside Toolbox	Aluminum	Yes	16in	13in	96in	Buyers
B1702840	Topside Tool Box	White		16in	13in	72in	Buyers
B1702850	Topside Toolbox	White	Yes	16in	13in	88in	Buyers
B1702860	Topside Tool Box	White	Yes	16in	13in	96in	Buyers
B1702940	Topside Toolbox	Black		16in	13in	72in	Buyers
B1702960	Topside Toolbox	Black		16in	13in	96in	Buyers
B1705640	Topside Contractor Style Toolbox	Aluminum	Yes	21in	13-5/10in	72in	Buyers
B1705641	Topside Toolbox w/Drawers	Aluminum	Yes	21in	13.5/10in	72in	Buyers
B1705650	Topside Toolbox Contractor Style	Aluminum		21in	13-5/10in	88in	Buyers
B1705660	Topside Contractor Style Toolbox	Aluminum	Yes	21in	13.5/10in	96in	Buyers
B1707010	Box Chest	Aluminum	Yes	24in	22.5in	48in	Buyers
B1710400	Gull Wing Toolbox	Black		17in	20in	69in	Buyers
B1711206	Pork Chop Toolbox	Aluminum	Yes	8-1/2-19in	9-1/4in	46-1/4in	Buyers
B1711210	Pork Chop Toolbox	Aluminum	Yes	19in	13in	46-1/4in	Buyers
B1712010	All -Purpose Toolbox	Aluminum	Yes	19in	16in-20in	47in	Buyers
B1712020	All-Purpose Toolbox	Aluminum	Yes	19in	20in	54in	Buyers
B1712030	Box Chest	Aluminum	Yes	19in	20in	60in	Buyers
B1712035	All-Purpose Toolbox	Aluminum	Yes	19in	27in	60in	Buyers
B1712040	Gooseneck Toolbox	Aluminum	Yes	15in	19in	57in	Buyers
B1712230	All-Purpose Polymer Toolbox	Black		14-7/8in	13-11/16in	32-1/8in	Buyers
B1712240	All-Purpose Polymer Tool Box	Black		19in	17-1/2in	44-3/8in	Buyers
BP825524	B-Pack Underbody Toolbox	Aluminum	Yes	55in	24in	82in	Buyers
BP925824	B-Pack Toolbox	Aluminum	Yes	58in	24in	92in	Buyers

Cargo Control

Tool Boxes Underbody Toolboxes Black



Polymer

A: Height B: Depth C: Width D: Mfg.

Item Number	Description	SO	A	B	C	D
B1702100	Toolbox		18in	18in	24in	Buyers
B1702110	Toolbox	Yes	18in	18in	48in	Buyers
B1702300	Toolbox		18in	18in	24in	Buyers
B1702303	Toolbox		18in	18in	30in	Buyers
B1702305	Toolbox		18in	18in	36in	Buyers
B1702310	Toolbox		18in	18in	48in	Buyers
B1702315	Toolbox		18in	18in	60in	Buyers
B1702325	Toolbox		18in	18in	72in	Buyers
B1703103	Toolbox	Yes	14in	16in	30in	Buyers
B1703300	Tool Box w/T-Handle		14in	16in	24in	Buyers
B1703303	Toolbox	Yes	14in	16in	30in	Buyers
B1703305	Toolbox w/T-Handle		14in	16in	36in	Buyers
B1703330	Toolbox		16in	14in	18in	Buyers
B1703350	Toolbox w/T-Handle		14in	12in	24in	Buyers
B1703700	Toolbox	Yes	14in	16in	24in	Buyers
B1703703	Toolbox	Yes	14in	16in	30in	Buyers
B1703705	Toolbox		14in	16in	36in	Buyers
B1704300	Toolbox w/T-Handle	Yes	24in	24in	24in	Buyers
B1704303	Toolbox	Yes	24in	24in	30in	Buyers
B1704305	Toolbox w/T-Handle		24in	24in	36in	Buyers
B1704310	Toolbox w/T-Handle	Yes	24in	24in	48in	Buyers
B1704315	Toolbox w/T-Handle	Yes	24in	24in	60in	Buyers
B1704705	Toolbox	Yes	24in	24in	36in	Buyers
B1704710	Toolbox	Yes	24in	24in	48in	Buyers
B1717105	Toolbox w/T-Handle Poly		18in	18in	36in	Buyers
BP855524B	Toolbox B-Pack Style	Yes	55in	24in	85in	Buyers

Cargo Control

Tool Boxes Underbody Toolboxes Black/SS Door



A: Height B: Depth C: Width D: Mfg.

Item Number	Description	SO	A	B	C	D
B1702700	Toolbox		18in	18in	24in	Buyers
B1702705	Toolbox		18in	18in	36in	Buyers
B1702710	Toolbox		18in	18in	48in	Buyers
B1702715	Toolbox	Yes	18in	18in	60in	Buyers

Stainless

A: Height B: Depth C: Width D: Mfg.

Item Number	Description	SO	A	B	C	D
B1702600	Toolbox	Yes	18in	18in	24in	Buyers
B1702603	Toolbox	Yes	18in	18in	30in	Buyers
B1702605	Toolbox	Yes	18in	18in	36in	Buyers
B1702610	Toolbox	Yes	18in	18in	48in	Buyers



White

A: Height B: Depth C: Width D: Mfg.

Item Number	Description	SO	A	B	C	D
B1702205	Toolbox	Yes	18in	18in	36in	Buyers
B1702215	Toolbox	Yes	18in	18in	60in	Buyers
B1702400	Toolbox	Yes	18in	18in	24in	Buyers
B1702403	Toolbox	Yes	30in	18in	18in	Buyers
B1702405	Toolbox	Yes	18in	18in	36in	Buyers
B1702410	Toolbox		18in	18in	48in	Buyers
B1702415	Toolbox	Yes	18in	18in	60in	Buyers
B1703203	Toolbox	Yes	14in	16in	30in	Buyers
B1703403	Toolbox	Yes	14in	16in	30in	Buyers
B1703405	Toolbox	Yes	14in	16in	36in	Buyers
B1704400	Toolbox	Yes	24in	24in	24in	Buyers
B1704403	Toolbox	Yes	24in	24in	30in	Buyers
B1704405	Toolbox	Yes	24in	24in	36in	Buyers
B1704410	Toolbox	Yes	24in	24in	48in	Buyers



Cargo Control

Tool Boxes Underbody Toolboxes Aluminum

A: Height B: Depth C: Width D: Mfg.

Item Number	Description	SO	A	B	C	D
B1702240	Toolbox Barn Door Style	Yes	24in	24in	48in	Buyers
B1705103	Toolbox w/T-Handle		18in	18in	30in	Buyers
B1705105	Toolbox w/T-Handle		18in	18in	36in	Buyers
B1705110	Toolbox w/T-Handle		18in	18in	48in	Buyers
B1705115	Toolbox	Yes	18in	18in	60in	Buyers
B1705130	Toolbox	Yes	24in	24in	24in	Buyers
B1705133	Toolbox	Yes	24in	24in	30in	Buyers
B1705135	Toolbox	Yes	24in	24in	36in	Buyers
B1705140	Toolbox	Yes	24in	24in	48in	Buyers
B1705150	Toolbox w/T-Handle	Yes	14in	16in	24in	Buyers
B1705160	Toolbox	Yes	14in	16in	24in	Buyers
B1705201	Toolbox w/T-Handle	Yes	18in	18in	18in	Buyers
B1705205	Toolbox Barn Door Style	Yes	18in	18in	36in	Buyers
B1705210	Toolbox Barn Door Style	Yes	18in	18in	48in	Buyers
B1705215	Toolbox w/T-Handle	Yes	18in	18in	60in	Buyers



Trailer Tongue Tool Boxes



Steel



Aluminum



Poly

A: Length 1 B: Length 2 C: Depth D: Height E: Mfg.

Item Number	Description	Color	SO	A	B	C	D	E	Extra Info
B1701280	Toolbox	Black		34in	20.75in	14.25in	16in	Buyers	Steel
B1701281	Toolbox	Black		26in	14in	13.25in	12in	Buyers	Steel
B1701285	Toolbox	Black		48in	33in	16in	16in	Buyers	Steel
B1701380	Toolbox	Aluminum		34in	22.5in	14.5in	15in	Buyers	Diamond Plated
B1701385	Toolbox	Aluminum		49in	37in	15in	18.5in	Buyers	Diamond Plated
B1701679	Toolbox	White	Yes	36in	18in	19in	18in	Buyers	Poly
B1701680	Toolbox	Black		36in	18in	19in	18in	Buyers	Poly

Cargo Control

Shelves & Accessories Phoenix



A: Height B: Width C: Depth

Item Number	Description	Color	SO	A	B	C
SP1025DBA	Double Bracket Hanger	Aluminum		3.5in	10.25in	2.5in
SP12AT	Tow-Rax Tray for Aerosol Cans	Aluminum	Yes	4in	33.5in	4in
SP135FLHOA	Flashlight Holder	Blk/Wht		5.25in	2.75in	2.75in
SP180CSA	Jr. Cabinet for Oil Cans	Aluminum	Yes	17.5in	16in	5.5in
SP24HR	Tubular Gear Shelf	Stainless		12.6in	25.9in	16.3in
SP25BK	Mounting Button Kit	Aluminum		2.5mm	N/A	N/A
SP25SHA	Strap Hanger	Aluminum		4.5in	17in	3in
SP26AST	Strap Track	Aluminum	Yes	N/A	26in	N/A
SP280HSA	Side Hanger Shelf	Aluminum		10.5in	28in	15in
SP28TBTA	Toolbox Tray	Aluminum	Yes	18in	28in	13.5in
SP2BRA	Dual Jug Rack	Aluminum		12in	25in	12.5in
SP2CH	Cup/Can Holder	Aluminum		----	----	----
SP30ATC	Tool Cabinet w/Fold Down Tray	Aluminum		30in	25.5in	3in
SP30BK	Mounting Button Kit SP45HFTA	Aluminum		3mm	N/A	N/A
SP30CDS	Storage Cabinet w/Stainless door	Aluminum		30in	25.5in	9in
SP30CSA	Storage Cabinet w/Tray	Aluminum	Yes	30in	25.5in	9in
SP35SBA	Single Bracket Hanger	Aluminum		3.5in	3.5in	2.5in
SP36CCA	Combo Cabinet w/3 Shelves	Aluminum		36in	25.5in	9in

Cargo Control & Accessories

Cargo Control

Shelves & Accessories Phoenix (Continued)



A: Height B: Width C: Depth

Item Number	Description	Color	SO	A	B	C
SP45HFTA	Folding Table	Aluminum		3in	45in	18in
SP48HR	Tubular Gear Shelf	Stainless		12.6in	49.9in	16.3in
SP50CKA	Channel Kit Set of 2	Aluminum		3.25in	50in	.75in
SP8SHA	Strap Hanger	Aluminum		4.5in	8in	3in
SPCHH	Corner Helmet Shelf	Aluminum		21in	14.25in	15.75in
SPGD	Latex Glove Dispenser	Aluminum	Yes	5.1in	10in	3.3in
SPHHA	Single Helmet Hook	Aluminum	Yes	4in	6in	4in
SPJCA	Jr. Storage Cabinet w/Folding Tray	Aluminum		23in	12in	9in
SPJSTAL	Hydraulic Floor Jack Rack	Aluminum	Yes	2.5in	16in	2in
SPKPB	Key Punch Bracket Kit	Stainless		2in	2in	1in
SPPTH	Spring Loaded Towel Roll Holder	Aluminum		N/A	N/A	N/A
SPRLB	Work Light Housing	Aluminum	Yes	11.5in	12.5in	5.5in
SPRLBL	Work Light w/Housing	Aluminum	Yes	11.5in	12.5in	5.5in
SPSAGHA	Air Gauge Holder	Aluminum	Yes	N/A	N/A	N/A
SPSCBA	Cord & Hose Hanger	Aluminum		5.9in	4in	4in
SUSD24SK	Adjustable Shelf	Galvanized		24in	18in	18in
SUSD36SK	Adjustable Shelf	Galvanized		36in	18in	18in
SUSD48SK	Adjustable Shelf	Galvanized		48in	18in	18in

Cargo Control

Bumper Accessories Mudflaps

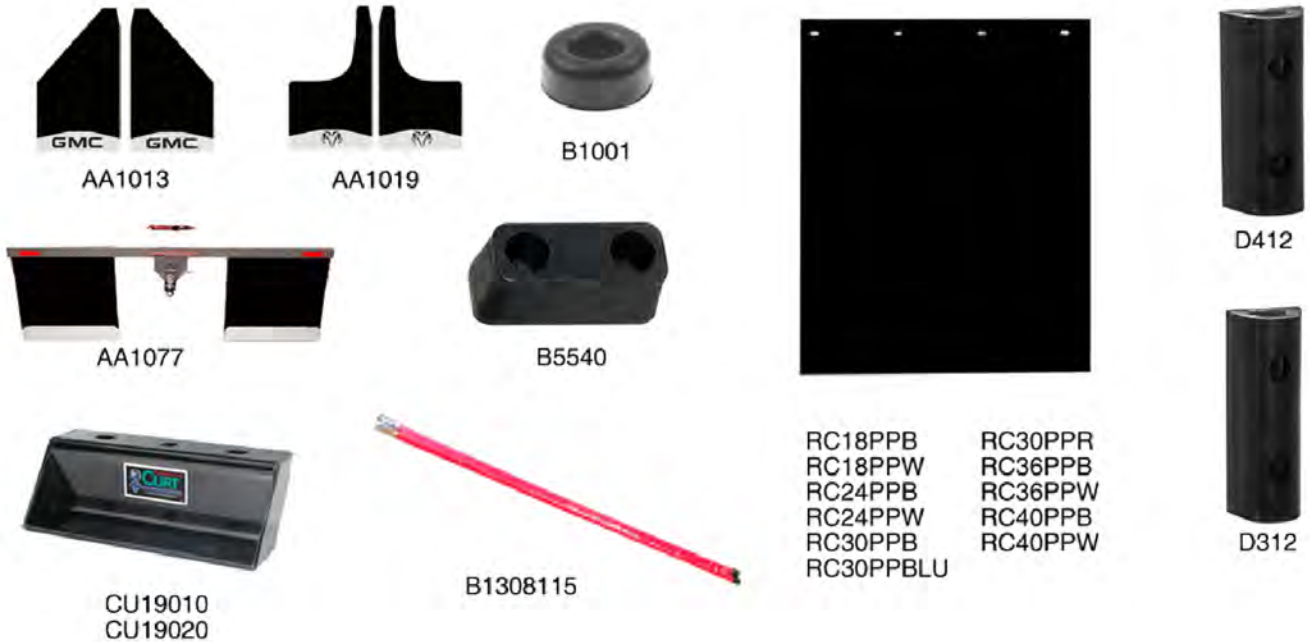

A: Width B: Height C: Mfg.

Item Number	Description	SO	A	B	C
AA1013	Front Mud Flaps GMC Logo	Yes	12in	20-1/2in	Tuff-Tow
AA1019	Front Mud Flaps Dodge Logo	Yes	12in	20-1/2in	Tuff-Tow
AA1076-8	Mud Flap Flames F150	Yes	----	----	Tuff-Tow
AA1077	Rear Mount Mud Flaps	Yes	24in	76in	Tuff-Tow
B1001	Round Rubber Bumper		2-1/2in	----	Buyers
B1308115	Fluorescent Orange Marker Kit		3/4in	48in	Buyers
B52150	Rubber Fender Extension	Yes	50ft	----	Buyers
B5500	Molded Rubber Bumper		3in	6in	Buyers
B5540	Molded Rubber Bumper		2-9/16in	6in	Buyers
CU19010	Step Bumper Receiver-4in Drop		----	----	Curt
CU19020	Step Bumper Receiver-6in Drop		----	----	Curt
D312	Rubber D-Bumper		3in	12in	Buyers
D412	Rubber D-Bumper	Yes	4in	12in	Buyers
RC18PPB	Durable Black Mudflap	Yes	24in	18in	Buyers
RC18PPW	Durable White Mudflap	Yes	24in	18in	Buyers
RC24PPB	Durable Black Mudflap	Yes	24in	24in	Buyers
RC24PPW	Durable White Mudflap	Yes	24in	24in	Buyers
RC30PPB	Durable Black Mudflap	Yes	24in	30in	Buyers
RC30PPBLU	Durable Blue Madflap	Yes	24in	30in	Buyers
RC30PPR	Durable Red Mudflap	Yes	24in	30in	Buyers
RC36PPB	Durable Black Mudflap	Yes	24in	36in	Buyers
RC36PPW	Durable White Mudflap	Yes	24in	36in	Buyers
RC40PPB	Durable Black Mudflap	Yes	24in	40in	Buyers
RC40PPW	Durable White Mudflap	Yes	24in	40in	Buyers

Cargo Control

Mirrors

Cipa Custom Towing Mirrors

Product Image	CIPA #	Years	Applications	Exceptions/info	Fits Over
	CA10000 (Fits Driver or Pass)	86-95	DODGE pickups and Vans		
	CA10300 (Fits Driver or Pass)	94-97	DODGE pickups and Vans		
	CA10500-Pair CA10501-Driver CA10502-Pass	94-02 98-03 98-04 00-03	DODGE Old Style 1500, 2500, 3500 DODGE Durango DODGE Dakota DODGE Full-Size Van		
	CA10700-Pair CA10701-Driver CA10702-Pass	02-08 03-08	DODGE Ram 1500 DODGE Ram 2500, 3500		
	CA11400-Pair CA11401-Driver CA11402-Pass	09-16 09-17	DODGE Ram 1500 DODGE Ram 2500		
	CA11000 (Fits Driver or Pass)	83-98 83-91	FORD Full-Size Pickups FORD Ranger		
	CA11500-Pair CA11501-Driver CA11502-Pass	92-97 90-97 92-96 1997	FORD Full-Size Pickups FORD Aerostar FORD Bronco FORD F-250 & F-350 HD w/Old Body		
	CA11600-Pair CA11601-Driver CA11602-Pass	97-04 97-02 97-02	FORD F-150, F-250 Light Duty FORD Expedition LINCOLN Navigator		
	CA11700-Pair CA11701-Driver CA11702-Pass	97-02	FORD Full-Size Light Duty Pickups		
	CA11800-Pair CA11801-Driver CA11802-Pass	04-14 04-14	FORD F-150, F-250 Light Duty FORD F-150 & F-250 XLT Models		
	CA11900-Pair CA11901-Driver CA11902-Pass	97-08 00-08	FORD F-250, F-350 Super Duty FORD Excursion		
	CA11300-Pair CA11301-Driver CA11302-Pass	07-13 08-13	TOYOTA Tundra TOYOTA Sequoia		

Cargo Control

Mirrors

Cipa Custom Towing Mirrors

Product Image	CIPA #	Years	Applications	Exceptions/Info	Fits Over
	CA10000 (Fits Driver or Pass)	80-95	CHEVY/GMC Pickups & Vans	*Fits manual chrome mirrors only *Will not fit the chrome mirrors with black trim	
	CA11000 (Fits Driver or Pass)	82-93	CHEVY S-10, S-15	*Fits the chrome door-mount two-point break-away style mirror only	
	CA10200-Pair CA10201-Driver CA10202-Pass	88-00 92-99 92-99 91-04 92-99	CHEVY/GMC Full-Size C/K Pickups CHEVY/GMC Suburban, Yukon, Kodiak CHEVY Tahoe, Dually CHEVY/GMC Safari, Astro CADILLAC Escalade		
	CA10600-Pair CA10601-Driver CA10602-Pass	97-04 97-04 97-04	CHEVY Venture GMC Silhouette PONTIAC Transport		
	CA10800-Pair CA10801-Driver CA10802-Pass	99-07 00-07 00-07 00-07 00-07	CHEVY/GMC Silverado, Sierra CHEVY Tahoe, Suburban CHEVY Avalanche GMC Denali, Yukon, Yukon XL CADILLAC Escalade	*Fits black capped and chrome capped models *Will not fit full-chrome mirrors *Will not fit telescopic mirrors	
	CA10900-Pair CA10901-Driver CA10902-Pass	07-13 07-13 07-13 07-13	CHEVY/GMC Silverado, Sierra CHEVY Tahoe, Suburban CHEVY Avalanche GMC Denali, Yukon, Yukon XL CADILLAC Escalade	*Will not fit telescopic mirrors	
CUSTOM TOWING MIRROR REPLACEMENT HARDWARE					
CIPA #	Description	CIPA #	Description		
CA10002	Replacement Hardware for 10000	CA11503	Replacement Hardware for 11500		
CA10203	Replacement Hardware for 10200	CA11603	Replacement Hardware for 11600		
CA10303	Replacement Hardware for 10300	CA11703	Replacement Hardware for 11700		
CA10403	Replacement Hardware for 10400	CA11803	Replacement Hardware for 11800 (2004-2007 Models)		
CA10503	Replacement Hardware for 10500	CA11804	Replacement Hardware for 11800 (2008-2013 Models)		
CA10603	Replacement Hardware for 10600	CA11903	Replacement Hardware for 11900		
CA10703	Replacement Hardware for 10700	CA100GL	Replacement Glass for 10000, 10300, 10700, 11900		
CA10803	Replacement Hardware for 10800	CA110GL	Replacement Glass for 10100, 10200, 10400, 10500,		
CA10903	Replacement Hardware for 10900		10600, 11000, 11500, 11600, 11700		
CA11002	Replacement Hardware for 11000	CA10801GL	Replacement Glass for 10801, 10901, 11301		
CA11303	Replacement Hardware for 11300	CA10802GL	Replacement Glass for 10802, 10902, 11302		
CA11403	Replacement Hardware for 11400				

Cargo Control

Mirrors



Item Number	Description	SO
CA10002	Knob Hook Replacement for CA10000	Yes
CA10203	Hardware Replacement for CA10200	Yes
CA10803	Hardware Replacement for CA10802	Yes
CA11504	Adapter Kit	
CA11603	Replacement Hardware for 11600	Yes
CA11950	Clip-on Mirror	
CA11950STRAPS	Straps for Clip-on mirror	Yes
CA11953	Dual-View Towing Mirror	
CA11955	Fast Hitch Mirror	
CA11960	Universal Strap-On Mirror	
CA46300	GM-Chev Window Mount Mirror LH	Yes
CA46310	GM-Chev Window Mount Mirror RH	Yes
CA70802	Passenger Side Glass Repair Kit	Yes
CA72110	Mirror Replacement	Yes
CA83010	Replacement Mirror 83000 RH	Yes
CA95150	Slide-Out Door Mount Towing Mirror	Yes
CA95155	Slide-Out Door Mount Towing Mirror	Yes
CU20002	Towing Mirror	

Cargo Control

Mirrors Mirror Replacement Mirrors Universal



608



606



615



616



617X



653X



655X



821



822



823



830



833



835



CA47500



800



667X



810



815

A: Width B: Height C: Mfg.

Item Number	Description	Color	SO	A	B	C
608	Convex Stud Mount Mirror	Black		8-1/2in	8-1/2in	Peterson
615	Economy Mirror	Aluminum		6-1/2in	16in	Peterson
616	Flat Ribbed Mirror	Black		7in	16in	Peterson
617X	Replacement Mirror	Stainless		6-1/2in	16in	Peterson
653X	Mirror Mount Fender	Stainless		5-1/4in	8-1/2in	Peterson
655X	Convex Clamp-On Mirror	Stainless		6in	6in	Peterson
658X	Mirror Head	Stainless	Yes	8-1/2in	8-1/2in	Peterson
667X	West Coast Mirror Adj 18-25in	Stainless	Yes	6-1/2in	16in	Peterson
810	Universal Swing Away Mirror	Stainless		7-1/2in	10-1/2in	Peterson
821	Mirror Assembly	Stainless		7-1/2in	10-1/2in	Peterson
830	Universal Mirror Replacement	Stainless		5in	7in	Peterson
832	Mirror Head Replacement	Stainless	Yes	7-1/2in	10-1/2in	Peterson
833	Universal Mirror Replacement	Stainless	Yes	8-3/4in	6in	Peterson
835	Universal Mirror Head	Black		8-1/2in	5-1/2in	Peterson
CA11120	Side Mount Mirror	Black	Yes	3-1/2in	5-3/8in	Cipa
CA11121	Side Mount Mirror	White	Yes	3-1/2in	5-3/8in	Cipa
CA47500	Jr West Coast Universal Mirror	Stainless	Yes	5in	10in	Cipa

Cargo Control

Mirrors JR Products



1953



1984



2899



2912



1960

A: Width B: Height

Item Number	Description	Color	A	B
1953	Mirror Replacement Pads-2pk	Black	N/A	N/A
1960	Mirror Clamp	Black	N/A	N/A
1984	Areo2 Mirror Replacement Head	Black	6in	5in
2899	Aero2 Towing Mirror-2pk	Black	6in	5in
2912	Grand Aero Towing Mirror-2pk	Black	6in	9in
3100	Aero Blind Spot Mirror	Black	6-1/2in	5-1/2in



CU11954



V580



V600 - V603L



3100

A: Width B: Height C: Mfg.

Item Number	Description	Color	SO	A	B	C
CA11954	Suction Cup Towing Mirror	Black	Yes	4.5in	5.5in	Cipa
V599	Adjustable Wedge Blind Spot Mirror	Black/Chrome		1-1/2in	2-3/16in	Peterson
V600	Convex Stick-On Mirror	Black		2in	2in	Peterson
V603	Blind Spot Mirror	Black		3in	3in	Peterson

Cargo Control

Receiver Covers & Accessories Hitch Receiver Covers 1 1/4 in.



A: Receiver B: Mfg.

Item Number	Description	Color	A	B
CU21900	Receiver Cover	Chrome	1-1/4in	Curt
CU21901	Receiver Cover	Chrome	1-1/4in	Curt
CU22271	Receiver Cover Trailer Hitch	Black	1-1/4in	Curt
CU22275	Receiver Cover	Rubber	1-1/4in	Curt

Hitch Receiver Covers 2 in.



A: Receiver B: Mfg.

Item Number	Description	Color	SO	A	B
CU21728	Receiver Cover Rubber Cap	Black		2in	Curt
CU22100	Receiver Cover	Chrome		2in	Curt
CU22101	Receiver Cover	Chrome		2in	Curt
CU22110	Receiver Cover	Chrome		2in	Curt
CU22111	Receiver Cover	Chrome		2in	Curt
CU22170	Receiver Cover	Chrome		2in	Curt
CU22171	Receiver Cover	Chrome		2in	Curt
CU22180	Receiver Cover Plastic	Black		2in	Curt
CU22181	Receiver Cover Plastic	Black		2in	Curt
CU22272	Receiver Cover Curt Logo	Black		2in	Curt
CU22276	Receiver Cover Rubber	Black		2in	Curt
CU22750	Receiver Cover	Black		2in	Curt
CU22751-10	Receiver Cover	Yellow	Yes	2in	Curt
HS7000	Receiver Cover Safe	Black		2in	HitchSafe
HS7010	Receiver Rubber Cover	Black	Yes	2in	HitchSafe
HS7020	Receiver Cover Replacement Pin	Chrome	Yes	N/A	HitchSafe
HS7021T	Receiver Cover 5/8in Pins-2 Toyota	Chrome		N/A	HitchSafe

Cargo Control

Receiver Covers & Accessories

Receiver Accessories

A: Receiver Size B: Length C: Mfg.



Item Number	Description	Color	A	B	C
B1804015	Receiver Extension	Black	2in	12in	Buyers
CU31001	Step Pad	Black	2in	11in	Curt
CU31002	License Plate Holder	Black	2in	12in	Curt
CU31005	Winch Mount Handle	Black	N/A	N/A	Curt
CU31006	Spare Tire Mount	Black	2in	24in	Curt
CU31007	Skid Shield	Black	2in	6in	Curt
CU31009	Winch Plate & Handle Assembly	Black	2in	13in	Curt
CU31010	Winch Mount Plate	Black	2in	13in	Curt
CU45500	Tow Hook Mount	Black	2in	N/A	Curt
CU45825	Tow Hook Mount	Black	2in	N/A	Curt
SBH2	Hitch Receiver Step Bumper 3.5k	Black	2in	8-1/2in	Buyers
SW2546	Receiver Bracket Shackle	Black	2in	8in	SuperW

Motor Cycle Covers

ATV Covers



Item Number	Description	Color	SO
CL65-005-033501	Motor Cycle Cover	Blue/Silver	
CL65-006-043501	Motor Cycle Cover	Blue/Silver	Yes
CL70563	PolyPro 3 Class A RV Cover	Gray	Yes
CL71003-C	Deluxe 4 Layer Car Cover	Gray	Yes
CL71152F/E	Deluxe Polypro Car Cover	Gray	Yes
CL72136	3 & 4 Wheel ATV Cover	Camo	
CL78213	3 & 4 Wheel ATV Cover	Olive	

Spare Covers

A: Tire Min B: Tire Max C: Model #



Item Number	Description	Color	A	B	C
CL75120	Tire Cover	Snow White	25-1/4in	26-1/2in	3
CL75130	Tire Cover	Snow White	26-3/4in	27-3/4in	4
CL75140	Tire Cover	Snow White	28in	29in	5
CL75150	Tire Cover	Snow White	29in	29-3/4in	6
CL75160	Tire Cover	Snow White	30in	30-3/4in	7
CL75387	Tire Cover	Black	30in	33in	Lg

Cargo Control

Suspension Enhancement Firestone Ride-Rite

Firestone

World's Number 1
Air Spring.

FIRESTONE INDUSTRIAL PRODUCTS COMPANY

Benefits of Air Springs

- Reduce bottoming out
- Increase vehicle stability
- Reduce sway
- Absorb road shock
- Reduce suspension fatigue



Ride-Rite™ Air Helper Springs

- Provides better ride support through the use of air pressure
- Air can be adjusted for varying loads
- Easy Install - Most kits are no drill



Work-Rite™ Load Assist Springs

- Injection-molded spring
- Adjustable for individual loads using spacers instead of air
- Maintenance free



Level-Rite™ Air Helper Springs

- Air Spring paired with Bilstein monotube shock absorber
- Reversible sleeve air spring
- Perfect leveling solution for front end trucks and SUVs that have a snow plow, haul a slide in camper or have heavy grill guards or bumpers



Coil-Rite™ Air Helper Springs

- Air Helper springs made for vehicles with coil spring suspensions
- Air can be adjusted for varying loads



Cargo Control & Accessories

Cargo Control

Suspension Enhancement Firestone Ride-Rite



R4Tech™



R4Tech is a proprietary, hybrid air-over-leaf suspension system, designed and manufactured by SANLUIS Rassini



A complete R4Tech kit includes leaf springs, trailing links with J-springs, air springs, load adaptive shocks, air compressor and tank, and all necessary hardware.

Ask your sales representative for a current Vehicle Fit Guide, or visit wholesaletrailer.com

Big rig trucks use air suspension for a reason. Airide™ suspensions ride better than steel spring suspensions, reduce the wear and tear on your equipment and protect both the driver and cargo, regardless of the load.

The R4Tech suspension is a proprietary (patent pending), hybrid air-over-leaf suspension that provides the ride quality of a full-air suspension, the axle control of a leaf spring and the ease of installation of a standard leaf spring and Ride-Rite kit.

The foundation R4Tech suspension is designed and manufactured by SANLUIS Rassini, the preeminent supplier of leaf springs to the North American light truck industry. When combined with Firestone Airide™ air springs and Ride-Rite™ air accessories, the result is R4Tech, a suspension kit that is unmatched in terms of durability, reliability and ride quality.

Each application is carefully designed and tuned to improve the ride quality and handling performance of the factory vehicle.

Ride-Rite LS



Ride-Rite LS is Firestone's line of load adaptive shocks and is a key component of the R4Tech premium suspension system and is an ideal upgrade to Ride-Rite air helper springs. Ride-Rite LS is a tri-tube mono-flow shock absorber designed to deliver superior performance under a full range of load and temperature conditions. The damping level is automatically controlled by the air pressure inside the spring, so there is no need to crawl under the truck to adjust the shocks. This easy-to-install product comes complete with air line and "T" fittings.

Load Assist Spring Features	R4Tech™	Ride-Rite™	Work-Rite™
Cost Indicator	\$\$\$\$	\$\$	\$
Most Kits Are No Drill	Yes	Yes	Yes
Avg. Install Time	6-7 hrs.	1-2 hrs.	30-40 min.
Special Tools	No	No	No
Optional Accessories	See pgs. 58-59	See pgs. 58-59	See pgs. 58-59
Min-Max psi	20-100	5-100	n/a
Increases vehicle stability & reduces sway	Yes	Yes	Yes
Absorbs road shock	Yes	Yes	Yes
Reduces suspension fatigue	Yes	Yes	Yes
Keeps vehicle level	Yes	Yes	
Air adjustable to level off-center loads	Yes	Yes	
Improves loaded ride	Yes	Yes	
Airide suspension for pickup trucks	Yes		
Greatly improves ride quality, especially unloaded	Yes		
Kneeling feature lowers rear of vehicle 5+"	Yes		
Includes compressor kit & load adaptive shocks	Yes		

WWW.RIDE-RITE.COM

Cargo Control

Suspension Enhancement Firestone Ride-Rite

Ride-Rite™ Air Helper Springs



Ride-Rite kits improve the handling of most light trucks, motor-homes, RVs, SUVs and vans.



Air springs, brackets, hardware, air line, and separate valves for manual inflation are all included for a straightforward installation.

Ask your sales representative for a current Vehicle Fit Guide, or visit wholesaletrailer.com

Firestone's most popular and comprehensive air helper spring line, Ride-Rite kits can be installed on most light trucks, motor-homes, RVs, SUVs and vans. Each application is specifically designed to maximize the vehicle's safe load-carrying capacity, stability, ride quality and brake effectiveness.

Firestone Ride-Rite air helper springs provide load support through the use of air pressure that can be adjusted for changing loads. They enhance the ride by reducing inter-leaf friction.

The system features individual inflation valves that allow for separate side-to-side or front-to-rear adjustment, which helps keep the vehicle level when carrying off-center loads and maintains ride quality under differing load conditions.

Most Ride-Rite kits are no-drill systems, designed to use the vehicle's factory holes and mount between its frame and suspension. All the components are included in the kit for an easy installation that typically takes 1 to 2 hours. Kits come with a two-year limited warranty.



Like Ride-Rite air helper springs, the Sport-Rite air springs improve the ride and handling. While Ride-Rite kits include convoluted style air springs, Sport-Rite kits include innovative tapered sleeve air springs, which are more conducive for specific applications. Sport-Rite kits support up to 3,000 lbs. per set (not to exceed vehicle's GVWR) and should be maintained between 10-100 psi.

Work-Rite™ Load Assist Springs



The progressive load-deflection characteristics of the Work-Rite kit will smooth your ride when your vehicle is fully loaded, and won't compromise your ride when it's not.

These load assist springs are injection-molded, and are made of microcellular urethane. They do not use air like the Ride-Rite family of springs so there is no air pressure to monitor. They are adjustable for individual loading scenarios using spacers provided in each kit.

There are eight separate spring-geometry and stiffness combinations for several applications for light duty trucks, vans and SUVs. Most Work-Rite kits are a no-drill design, which means they use the existing holes in the frame for installation and require only simple hand tools.

The Work-Rite load assist springs are maintenance-free with a limited lifetime spring warranty and provide a more comfortable, safer ride for you and your cargo.



Work-Rite kits contain load assist springs, brackets, and hardware for a this quick installation. Spacers may also be used.

Cargo Control & Accessories

Cargo Control

Suspension Enhancement Firestone Ride-Rite



Coil-Rite™ Air Helper Springs

If you're looking for a smoother ride for your vehicle that has a coil spring suspension, Firestone Coil-Rite air helper springs are what you need. Designed to fit inside existing coil springs to create a variable spring rate, Coil-Rite will level your vehicle and assist with more effective braking and handling, even under heavy loading and adverse road conditions.



Designed for cars, minivans, vans, light trucks, RVs and SUVs that have coil springs.

Coil-Rite enables you to control the air pressure in the air helper springs so you can make adjustments for varying loads and road conditions. Spring performance can be altered as easily as inflating a tire.

Firestone Coil-Rite air helper springs are made of durable, elastic polyurethane, providing years of comfort and stability to your vehicle. The air springs will support 500-1000 lbs. per set (not to exceed vehicle's GVWR). Coil-Rite Air Helper Springs are designed to work in temperatures between 180°F (82°C) and -40°F (-40°C).

Air helper springs, hardware, air line and separate valves for manual inflation are all included in the Coil-Rite kit.



Level-Rite™ Air Helper Springs

Certain factory suspension configurations do not allow the fitment of a stand-alone air spring. In these instances, it is necessary to pair the air spring with the shock absorber to achieve meaningful load capability while maintaining a hassle-free installation. For these applications, Firestone has designed a fully-protected, reversible sleeve air spring and paired it with a high-performance Bilstein monotube shock absorber for perfectly matched performance characteristics over the entire operation range.

Firestone's Level-Rite product provides the perfect leveling solution for the front end of late model Dodge, Chevrolet and GMC trucks and SUVs used for snow-plowing, hauling slide-in-campers or that have large, heavy grille guards.



Level-Rite products combine reversible sleeve air springs with high-performance shock absorbers.

Load Assist Spring Features	Coil-Rite	Level-Rite
Cost Indicator	\$	\$\$\$
Most Kits Are No Drill	Yes	Yes
Avg. Install Time	1 hr.	1 hr.
Special Tools	No	No
Optional Accessories	See pgs. 57-60	See pgs. 57-60
Min-Max psi	5-30	10-100
Increases vehicle stability & reduces sway	Yes	Yes
Absorbs road shock	Yes	Yes
Reduces suspension fatigue	Yes	Yes
Keeps vehicle level	Yes	Yes
Air adjustable to level off-center loads	Yes	Yes
Improves loaded ride	Yes	Yes

Ask your sales representative for a current Vehicle Fit Guide, or visit wholesaletrailer.com



Level-Rite kits contain a pair of reversible sleeve air springs paired with high-performance shock absorbers, tubing and all necessary hardware.

WWW.RIDE-RITE.COM

Cargo Control

Suspension Enhancement Firestone Ride-Rite

Dodge Ram Air Conversion System

If you own a Dodge Ram 1500 (2009-2013) with rear coil spring suspension, you may have noticed that when your truck is fully loaded, the bed of your vehicle sags considerably more than it would with a leaf spring suspension.

Firestone's solution to this problem is the Dodge Ram Air Conversion System. It is designed to replace the factory coil spring with an air spring, converting the rear suspension to an Airide™ suspension. The full air conversion provides a higher leveling capacity – up to the Gross Vehicle Weight Rating (GVWR) of the vehicle – than traditional systems, while smoothing the vehicle's ride.

Our Dodge Ram Air Conversion System keeps the vehicle level under all load conditions. The conversion maintains all the factory hardware and suspension geometry to seamlessly integrate the air springs with the factory coil spring retainers.

Easily installed with simple hand tools, the system improves steering and vehicle control while reducing bottoming out when adding a load. The Dodge Ram Air Conversion System allows for effortless loading and trailer attachment, thanks to the capability for a 6-inch kneel at the hitch by "exhausting" air from the springs. The kneeling feature is controlled by an in-cab switch; no calibration is required. The Firestone Dodge Ram Air Conversion System comes with a limited lifetime warranty on springs.



Ask your sales representative for a current
Vehicle Fit Guide, or visit
wholesaletrailer.com

The 2009-2013 Dodge Ram Air Conversion System (Part #2518) contains Airide™ springs, a Heavy Duty air compressor and 3 gallon tank, height sensors, kneel switch and hardware.



Our Dodge Ram Air Conversion System keeps the vehicle level under all load conditions.

Cargo Control

Suspension Enhancement Air Bags Air Compressor



See All In One Application Guide For Airbag Kits

Item Number	Description	SO
RR2097	Level Command Compressor Kit	
RR2158	Level Command II Accessory Kit	
RR2168	Dual Command Compressor Kit	
RR2178	Dual Electric Air Command	
RR2198	Dual Air Command III	Yes
RR2219	Level Command II HD Kit	
RR2239	Remote Fill Station	
RR2332	Compressor Electronic H Sensor	Yes
RR2497	Universal Compressor Mount	
RR2500	Wireless Quad System	Yes
RR2529	Universal Air Compressor Mount	
RR2541	Wireless Air Command Generation II	Yes
RR2543	Xtreme Classic Air Command	Yes
RR9124	Air Tank 1/2 Gallon 2 Ports	Yes
RR9125	Air Tank 1 Gallon 2 Ports	Yes
RR9126	Air Tank 2 Gallon	
RR9127	Air Tank 3 Gallon 2 Ports	Yes
RR9145	Air Tank 3 Gallon 3 Ports	Yes
RR9164	Compressor 4101	Yes
RR9191	Air Tank 5 gallon 2 ports	Yes
RR9227	Air Tank 3 Gallon	Yes
RR9229	Air Tank 3 Gallon 3/8 NPT	Yes
RR9242	Air Tank 5 Gallon 10 Ports	Yes
RR9248	Air Tank 5 Gallon 7 Ports	Yes
RR9270	HD Compressor 5-Gal 120 PSI	
RR9277	Air Tank 20 Gallon	Yes
RR9284	Air Compressor 100c	Yes
RR9285	Air Compressor 280c	
RR9289	Inflation Station II	
RR9377	Air Compressor	Yes

Cargo Control





Suspension Enhancement Firestone Ride-Rite

Air Springs

Firestone continues to raise the bar on high pressure and high quality air springs with our **RED LABEL™** edition. The air spring operates up to 150 PSI and has a test pressure of 400 PSI. *The Red Label parts are not intended to supplement the standard air springs in the Ride-Rite kits. The Red Label parts are intended for use on custom applications only.*

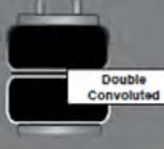
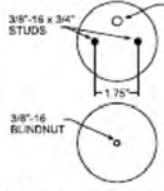
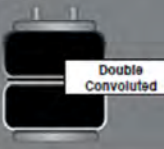
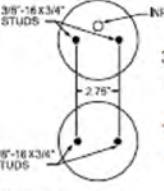
1/8 NPT=0.405" • 1/4 NPT=0.540" • 3/8 NPT=0.675" • 1/2 NPT=0.840"

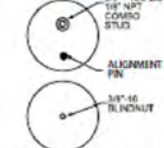
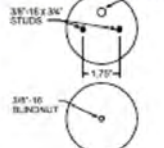
RED LABEL™ - HIGH PRESSURE AIR SPRINGS - up to 150 PSI

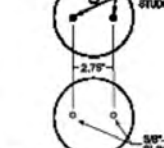
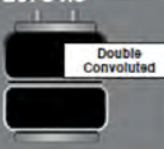
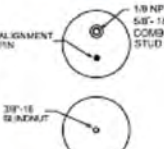
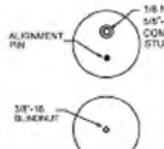
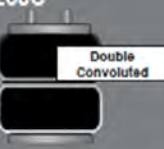
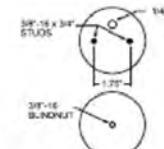
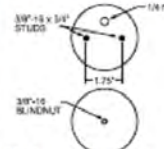
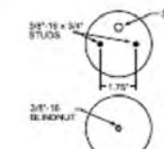
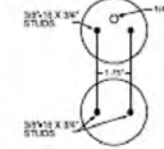
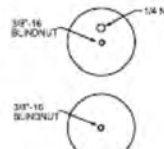
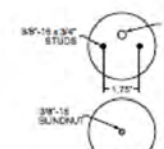
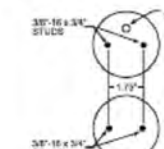









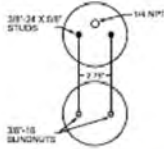
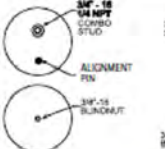
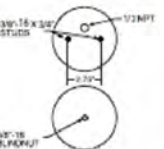
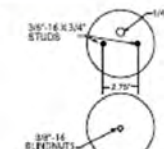
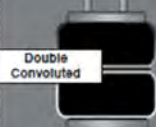
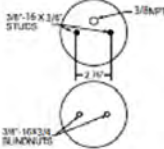
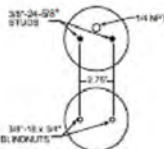
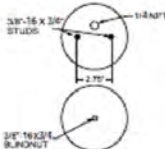
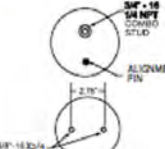

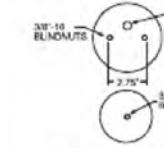
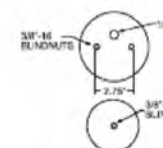
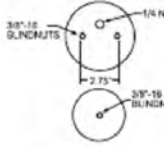
267C 1.5  Double Convoluted Compressed Height 2.60" Extended Height 8.30" Ride Height 5.50"- 6.50" Max. Diameter 6.60" 2400 lbs. per air spring*	 INFLATION PORT 3/8"-16 x 3/4" STUDS 1.75" 3/8"-16 BLINDNUT 3/8 NPT 7703 1/2 NPT 7671	224C  Double Convoluted Compressed Height 3.00" Extended Height 8.91" Ride Height 5.50"- 7.00" Max. Diameter 7.52" 2500 lbs. per air spring*	 INFLATION PORT 3/8"-16 x 3/4" STUDS 2.75" 3/8"-16 x 3/4" STUDS 3/8 NPT 7702 1/2 NPT 7668	
STANDARD AIR SPRINGS - up to 100 PSI				
160BY  Single Convoluted Compressed Height 3.00" Extended Height 6.50" Ride Height 5.00"- 6.00" Max. Diameter 7.20" 1800 lbs. per air spring*	6868  5/8"-18 x 3/4" COMBO STUD ALIGNMENT PIN 3/8"-16 BLINDNUT 1800 lbs. per air spring*	6869  1/4 NPT 3/8"-16 x 3/4" STUDS 1.75" 3/8"-16 BLINDNUT 1800 lbs. per air spring*	116B-1  Single Convoluted Compressed Height 2.10" Extended Height 7.50" Ride Height 5.00"- 6.00" Max. Diameter 9.20" 3000 lbs. per air spring*	1132  1/4 NPT 1/2"-18 x 1-3/4" STUDS 2.75" 3/8"-16 BLINDNUTS 3000 lbs. per air spring*
267C1.5  Double Convoluted Compressed Height 2.80" Extended Height 8.30" Ride Height 5.50"- 6.50" Max. Diameter 6.60" 2400 lbs. per air spring*	6397  1/8 NPT 5/8"-18 x 3/8" COMBO STUD ALIGNMENT PIN 3/8"-16 BLINDNUT 2400 lbs. per air spring*	6410  1/8 NPT 5/8"-18 x 1.75" COMBO STUD ALIGNMENT PIN 3/8"-16 BLINDNUT 2400 lbs. per air spring*	268C  Double Convoluted Compressed Height 2.80" Extended Height 7.00" Ride Height 4.50"- 5.50" Max. Diameter 6.40" 1600 lbs. per air spring*	6762  1/4 NPT 3/8"-16 x 3/4" STUDS 1.75" 3/8"-16 BLINDNUT 1600 lbs. per air spring*
6781  1/4 NPT 3/8"-16 x 3/4" STUDS 1.75" 3/8"-16 BLINDNUT 2400 lbs. per air spring*	6782  3/8 NPT 3/8"-16 x 3/4" STUDS 1.75" 3/8"-16 BLINDNUT 2400 lbs. per air spring*	6764  1/4 NPT 3/8"-16 x 3/4" STUDS 1.75" 3/8"-16 x 3/4" STUDS 1600 lbs. per air spring*	6784  1/4 NPT 3/8"-16 BLINDNUT 3/8"-16 BLINDNUT 2400 lbs. per air spring*	7882  1/2 NPT 3/8"-16 x 3/4" STUDS 1.75" 3/8"-16 BLINDNUT 2400 lbs. per air spring*
6765  3/8 NPT 3/8"-16 x 3/4" STUDS 1.75" 3/8"-16 x 3/4" STUDS 1600 lbs. per air spring*				

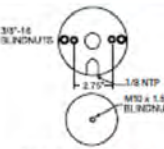
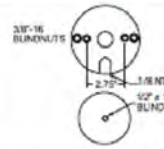
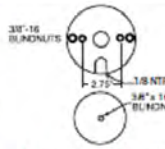
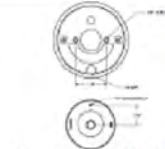
*Load is nominal @ 100 PSI. Load will vary with height & pressure.

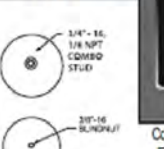
Cargo Control

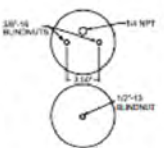
Suspension Enhancement Firestone Ride-Rite

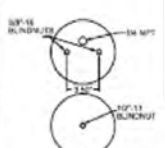
Air Springs

STANDARD AIR SPRINGS					
0335  2500 lbs. per air spring*	6401  2800 lbs. per air spring*	6776  2800 lbs. per air spring*	6872  2800 lbs. per air spring*	224C  Compressed Height 3.00" Extended Height 8.91" Ride Height 5.50"-7.00" Max. Diameter 7.52"	
6714  2800 lbs. per air spring*	7325  2800 lbs. per air spring*	7689  2800 lbs. per air spring*	7701  2800 lbs. per air spring*	26C  Compressed Height 3.00" Extended Height 9.00" Ride Height 7.00"-8.00" Max. Diameter 8.60"	
9000  1500 lbs. per air spring*	9001  1500 lbs. per air spring*	9002  1500 lbs. per air spring*		110/70  Max. Diameter 5.70"	
9041  1500 lbs. per air spring*	9042  1500 lbs. per air spring*	9043  1500 lbs. per air spring*	9047  1500 lbs. per air spring*	140/95  Max. Diameter 6.44"	
7076  1000 lbs. per air spring*	70mm  Compressed Height 3.95" Extended Height 10.50" Ride Height 7.00" Max. Diameter 5.00"	2107  3200 lbs. per air spring*	1T14C1  Compressed Height 4.25" Extended Height 13.60" Ride Height 9.80" Max. Diameter 9.10"	5405  3200 lbs. per air spring*	1T14C3  Compressed Height 5.80" Extended Height 15.75" Ride Height 10.50" Max. Diameter 9.10"

Load is nominal @ 100 PSI. Load will vary with height & pressure.

Cargo Control

Suspension Enhancement Firestone Ride-Rite

Lifted & Lowered Applications

Lift spacers can be used with most Ride-Rite™ air helper spring kits - NOT Coil-Rite™ or Sport-Rite™ kits. In order to ensure proper spacer usage, determine the distance between the upper and lower brackets of your air helper spring kit, and whether the kit mounts on the leaf spring or the axle. The spacer needs to be the same length as the amount of lift applied to the axle on which the air helper spring is being installed.

- Axle Mount - Lower bracket attaches to the axle
- Leaf Mount - Lower bracket attaches to the leaf stack

The lifted and lowered vehicle applications come complete with the necessary brackets, air springs, fittings and inflation valves for manual inflation.

Lift Spacers		Distance Between Brackets	Block Size	Axle Mount No.	Leaf Mount No.
		6.5" - 7.5"	1.25"	2536	2536
		7.5" - 8.5"	2"	2366	2366
		8.5" - 9.5"	3"	2368	2367
		9.5" - 10.5"	4"	2371	2370
		10.5" - 11.5"	5"	2373	2370
		11.5" - 12.5"	6"	2375	2374

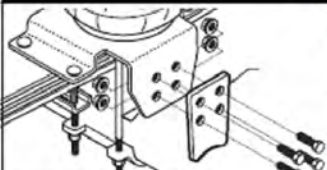
Axle Extension Brackets for Lifted Vehicles			
	Lift	Kit Number	Make/Model Number
	2"	2506	Tundra 07-13 2445
	3"	2507	
	4"	2508	
	5"	2509	
	6"	2510	

SOME KITS / BRACKETS MAY REQUIRE DRILLING. USE THE EXTENSION BRACKET AS A TEMPLATE TO MARK & DRILL THE HOLES.

Lifted Applications • lifted leaf springs					
	Make/Model	Lift	Year	Rear Kit	Air Spring
	Chevrolet C&R - 10,20,30,3500 (2WD only)	3" - 4"	73-87	2264*	6781
	Dodge Ram 1500 (2WD, 4WD)		77-01		
	Dodge Ram 2500, 3500 (2WD, 4WD)		77-02		
	Ford Bronco Full Size (4WD only)		90-96		
	Ford F100, F150, F250, F350 Pickups (2WD, 4WD)		63-96		
	Ford F250, F350 Over 8500 GVWR (2WD, 4WD)		97-10		

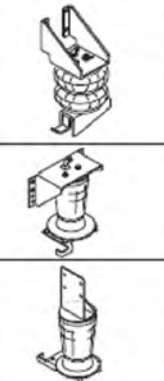
Lowered Applications					
	Make/Model	Lowered	Year	Rear Kit	Air Spring
	Chevrolet C1500 (w/c notch & axle flip) (4x2 only)	2" - 4"	88-98	2252*	6762
	Chevrolet/GMC Blazer/Jimmy		82-02	2516 +++	9001
	Chevrolet S10		82-04		
	Toyota Tacoma		95-04		
	Dodge Ram 1500		69-01	2517	
	Ford F100, F150		70-03		
	Chevrolet C1500		88-98		
	Chevrolet C1500		99-06		

Minimum Tire to Frame Clearance Requirements: * = 7.50", +++ = 6.50" • DO NOT EXCEED THE VEHICLE'S RECOMMENDED GROSS VEHICLE WEIGHT RATING (GVWR)

Cargo Control















Suspension Enhancement Firestone Ride-Rite

Service Parts

Dealer Fitting Pack 1		Dealer Fitting Pack 2		Dealer Fitting Pack 3	
	Part No. 2359		Part No. 2360		Part No. 2395
Includes 4 each: 1/4" union tees, inflation valves, 1/4 NPT elbow fittings		Includes 4 each: 1/4" union tees, inflation valves, 1/4 NPT elbow fittings and 2 each: 1/4" unions, 1/4 NPT straight fittings		Includes 6 each: 1/4 NPT elbow fittings, inflation valves •2 each: union tees, 1/4 NPT straight fittings, union fittings. Also includes 100' of 1/4" air line tubing	

Ride-Rite™/Sport-Rite™ Air Line Service Kit		Coil-Rite™ Air Line Service Kit	
	Part No. 2012		Part No. 4131 (or 2131 for 8 per box)
Description Includes 18' of red 1/4" air line, two 1/4 NPT elbow fitting, one union tee, and two inflation valves		Description Includes 18' of blue 1/4" air line with attached elbow fittings, two inflation valves, tie wraps, and fasteners	

Air Line Tubing							
Size	Length (ft)	Color	Part No.	Size	Length (ft.)	Color	Part No.
1/4"	18	Red	0938	1/4"	30	Black	9153
1/4"	22	Red	0937	3/8"	30	Black	9211
1/4"	30	Red	9008	3/8"	250	Black	9156
1/4"	100	Red	9145	3/8"	1000	Black	9143
1/4"	1000	Red	2135	1/2"	50	Black	9253
1/4"	18	Black	9151				

	Union Tee (Packages of 25) 1/4" Tubing 3025 3/8" Tubing 3105		Male Branch Swivel Tee (Packages of 25) 1/4" Tubing 3047 1/8 NPT 3047 1/4 NPT 3273
	Male Connector (Packages of 25) 1/4" Tubing 3055 1/8 NPT 3046 3/8" Tubing 3277 1/4 NPT 3104 1/2" Tubing 3157 3/8 NPT 3154		Male Elbow (Packages of 25) 1/4" Tubing 3128 1/8 NPT 3031 3/8" Tubing 3103 3/8 NPT 3153 1/2" Tubing 3289 3/8 NPT 3290
	Compressor Tee-3066 (Packaged Individually) 1/4" Tubing 1/8 NPT		Inflation Valve - 3032 (Packages of 25) 1/4" Tubing
	Pressure Switch (Packaged Individually) 1/8 NPT Male 90-120 PSI 9016 100-150 PSI 9193		Straight Female (Packages of 10) 1/4" Tubing 1/8 NPT 3082 1/4 NPT 3083
	Sealed Pressure Switch (Packaged Individually) 1/8 NPT Male 90-120 PSI 9401 • 110-145 PSI 9402		Union (Packages of 10) 1/4" Tubing 3079 1/4" - 3/8" Tubing 3114 Unequal Union
	Compressor Check Valve (Packages of 25) 1/8 NPT 9399		Tubing Cutter - 9009 (Packaged Individually)
	Fuse Tap Kit - 2526 (Packaged Individually) The Fuse Tap Kit provides an easy, low-impact method to connect the wire harness to the fuse box without splicing or soldering.		Ride-Rite Gloves (Packaged Individually) Small/Med. - 9345 Large - 9346

Cargo Control & Accessories

Cargo Control

Suspension Enhancement Firestone Ride-Rite

Air Components

Firestone offers a wide selection of air tanks ranging from 1/4 gallon to 20 gallons. These air tanks are coated internally and externally to resist corrosion. They are tested to SAE J10 compliance and capable of 150 PSI maximum pressure.

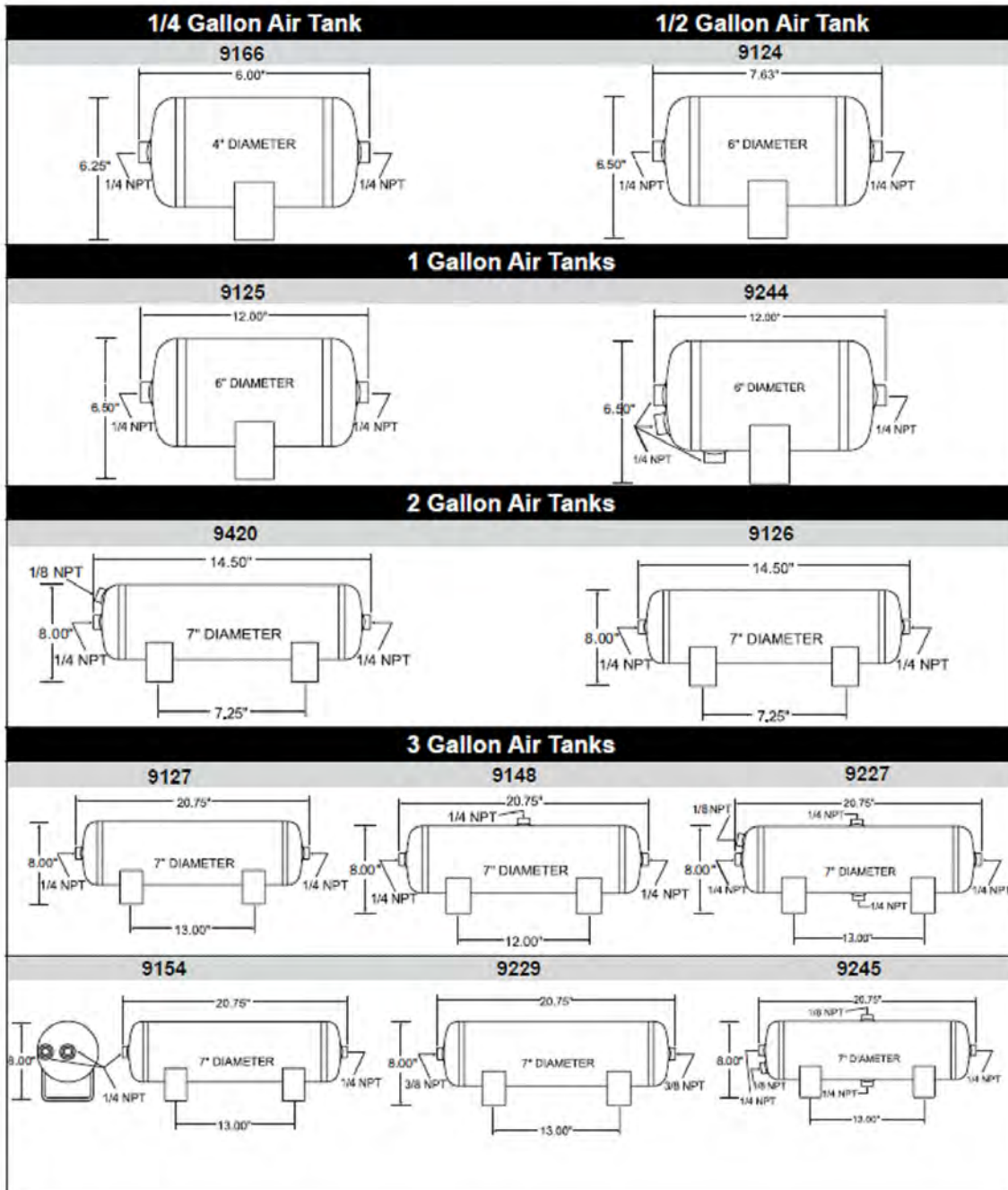

Cargo Control

Suspension Enhancement Firestone Ride-Rite

Air Components

5 Gallon Air Tanks

9191

9228

9231

9242

9243

9246

9248

20 Gallon Air Tank

9277

Extension Hose: Part No. 9006
The 25 ft. Extension Inflation Hose is included in the following popular Air Command Kits:

- 2047 Air Command
- 2540 Remote Air Command
- 2541 Heavy Duty Remote Air Command
- 2266 Xtra Air Command-Single
- 2168 Xtra Air Command-Dual
- 2546 Xtra Remote Air Command
- 2547 Xtreme Remote Air Command

Helpful Tools

The scale shown below may be used to assist in identifying the correct NPT (National Standard Taper Pipe Thread) fitting. Thread sealant is applied to the tapered threads. If the fitting is removed, use Teflon tape during reinstallation to prevent air leaks. If you need to replace a fitting, please see page 54 for replacement parts or call 800-888-0650.

SHOWN
IN ACTUAL
SIZE

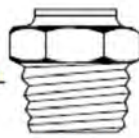

1/2 NPT

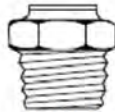

3/8 NPT



1/4 NPT



1/8 NPT





NPT Size	Nominal Outside Diameter
1/2	0.840"
3/8	0.675"
1/4	0.540"
1/8	0.405"

Cargo Control

Suspension Enhancement Firestone Ride-Rite

Air Accessory Mounting Kits

Firestone's Air Accessory Mounting Kits allow the compressor only, tank only or entire air accessory system to be pre-assembled table top, before the vehicle is on the lift. The plate with the assembled accessory system can easily be attached to the frame, without drilling using bail clamps.

2496	2529
 <p>FOR AIR TANKS Brackets clamp to vehicle with u-bolts. <i>Fits all Firestone Tanks</i></p>	 <p>FOR AIR COMMAND KITS Compressor, ECU and valve block mount to plate without drilling. Plate clamps to vehicle with u-bolts:</p> <p>Will Fit Kits: 2489 2490 2491 2540 2541</p>
2497	2530
 <p>FOR COMPRESSORS</p> <p>Will Fit Kits: 2097 2158 2178 2219 2538 9284 9285 9287 9377</p>	 <p>FOR AIR TANK AND COMPRESSOR</p> <p>Will Fit Kits: 2047 2168 2198 2232 2239 2266 2543 2549</p>



TECH TIP

- For 2546 Xtra Remote Air Command, use the 2529 and 2496.
- For 2547 Xtreme Remote Air Command, use the 2529 and 2530.



Air Accessory Mounting Kit (2529) shown with Kit 2541 preassembled.

Cargo Control

Suspension Enhancement Firestone Ride-Rite

Air Accessory Systems

Air-Rite™ Air Control Systems

Firestone has expanded the offering of Air-Rite Air Control Systems, which provides an instant air source for air suspension products. Adjust the ride for various load and road conditions with a flip of a switch or even a click on a remote. Individual air accessory components are also available, including compressors, air tanks and mounting solutions, providing a wide variety of air control assist solutions.

Choosing among the Air Command products has now become easier. To select an Air Command Kit from the table below, consider the level of air source and the style of gauge that best fits the application.

MODEL	Equal Pressure	Side-To-Side Leveling	Side-To-Side Leveling	Equal Pressure	Side-To-Side Leveling
	10 10	10 20	10 20	10 10	10 20
	Single Analog CLASSIC	Dual Analog CLASSIC	Dual Wireless REMOTE	Single Digital ELECTRONIC	Dual Digital ELECTRONIC
Light Duty •1 Year Warranty •Comes with 9377 Compressor 	2538		2554	2490	2491
Standard Duty •1 Year Warranty •Comes with 9284 Compressor 	2158	2178	2540	2544	2545
Heavy Duty •2 Year Warranty •Comes with 9285 Compressor 	2097	2219	2541		
Xtra •2 Year Warranty •1/2 gallon tank •Comes with 9285 Compressor 	2266	2168	2546		
Xtreme •2 Year Warranty •2 gallon tank •Comes with 9287 Compressor 	2543	2540	2547		



- A naming example from the above chart: The 2490 is the Light Duty Electronic Air Command kit and it includes the Light Duty compressor 9377, no air tank and the electronic gauge.
- The Classic Single, Electronic Dual and the Remote (used in 2540, 2541, 2546, and 2547) are shown in the above chart.

Cargo Control & Accessories

Cargo Control

Suspension Enhancement Firestone Ride-Rite

Air Accessory Systems

Level Command System™
Level command uses a height control valve mounted between the chassis and suspension. It is designed to keep the air helper springs at a controlled height.

2186 Shown:



Remote Fill Stations
The Remote Fill Stations offer an on-board air source for inflating air springs, tires and other pneumatic components. This includes a compressor, an air tank and a 25 ft. extension hose.

		XTRA	XTREME	HEIGHT SENSOR KIT	
Level Command™	Compressor Included	9285	9287		
	Air Tank Included	9124 1/2 gal.	9420 2 gal.		
	MECHANICAL	Single	2186 & 2047	2186 & 2548	2186
		Dual	2017 & 2047	2017 & 2548	2017
	ELECTRONIC	Single	2533 & 2047	2533 & 2548	2533
		Dual	2534 & 2047	2534 & 2548	2534

		XTRA	XTRA-3 gal.	XTREME
Remote Fill	PART NUMBER	2047	2239	2548
	Compressor Included	9285	9285	9287
	Air Tank Included	9124 1/2 gal.	9127 3 gal.	9420 2 gal.
	25 ft. Inflation Hose	9006	9195 incl. gauge	9195 incl. gauge



Android App Part No. 2556

The Firestone Ride-Rite Air Command™ Android app allows users to remotely adjust the amount of air in Firestone's air helper springs by conveniently turning a smart phone into the controller. The new app works with the Firestone Android Air Command Kit by providing an instant air source while delivering convenient adjustability to the air helper springs with the push of a button. The kit includes a Light Duty air compressor, Electronic Control Unit (ECU) and instructions for downloading the Firestone Ride-Rite Air Command™ Android app from Google Play.

Key Fob Part No. 2555

The Compact Remote Air Command System consists of a key fob controller, Electronic Control Unit (ECU) and a Light Duty air compressor. The key fob controller turns the Light Duty compressor on (up to 100 psi with a 9% duty cycle) to inflate the air helper springs and opens the exhaust valve to release air. This kit is easy to install, convenient and puts the power of air at your fingertips.

Cargo Control

Suspension Enhancement Firestone Ride-Rite

Air Accessory Components

Control Panels

Pneumatic	Replacement Gauge
White 2225	9181
Black 2149	9084

Pneumatic	Replacement Gauge
White 2241	9201
Black 2145	9074

Electric	Replacement Gauge
White 2229	9181
Black 2191	9084

Electric	Replacement Gauge
White 2260	9201
Black 2188	9074

Replacement Switches	
Pneumatic	9074 With Tank
Electric	9039 No Air Tank

Pneumatic Black 2333 **Monitoring Gauge White 2196**

TECH TIP

- Single control panels inflate and deflate one pair of air springs.
- Dual control panels inflate and deflate two individual air springs or two pairs
- Pneumatic control panels are used in systems that utilize tanks.
- Electric control panels do NOT require a tank.

COMPRESSORS

Firestone's air compressors are included in most Air Command™ systems and may also be purchased separately. All Firestone compressors are direct drive compressors (no oil or belts), so the compressors can be mounted in any position. Compressors should be mounted in a clean air location.

9377		9284		9285				
L 7.63		L 6.30		L 8.25				
W 2.11		W 3.27		W 3.94				
H 4.31		H 5.20		H 6.34				
2559		9287		9164				
L 8.4		L 11.24		L 12.54				
W 3.75		W 3.94		W 5.65				
H 7		H 6.85		H 8.86				
Air Compressor Description	Part No.	Max. Air Pressure	Duty Cycle	Max. AMP Draw	0 - 30 PSI*	0-60 PSI*	Wty** (yr)	Repl. Filter
Light Duty (Not for use with air tanks)	9377	120 PSI (8.3 BAR)	9%	10 AMPS	17 sec.	42 sec.	1	9129*
Standard Duty (Use with up to 1 gallon tank)	9284	130 PSI (9.0 BAR)	15%	20 AMPS	13 sec.	30 sec.	1	9350
Heavy Duty (Use with up to 3 gallon tank)	9285	150 PSI (10.4 BAR)	30%	18 AMPS	10 sec.	24 sec.	2	9418
High Performance (Use with 6 gallon tank)	2559	175 PSI (12.0 BAR)	50%	27 AMPS	9 sec.	18 sec.	2	9428
Xtreme (Up to 6 gallon tank)	9287	100 PSI (6.9 BAR)	100%	23 AMPS	7 sec.	18 sec.	2	-
Xtreme -alt (Up to 6 gallon tank)	9164	100 PSI (6.9 BAR)	100%	28 AMPS	-	-	2	-

TECH TIP

DO NOT SUBMERGE. The compressors are designed to withstand the normal driving conditions of debris and moisture. Care should be taken that the compressors are not submerged into water.

*Indicates flow rate - how long it takes to fill 1/2 gallon air tank.
** See product-specific warranty guidelines for more information regarding warrantable manufacturing defects.
*Packs of 10 filters.

FIRESTONE

Cargo Control

Suspension Enhancement Air Bags Air Lines, Fittings & Pressure Switch



RR2012



RR2360



RR9129



RR3025



RR3066



RR3079



RR3098



RR9193

Item Number	Description	SO
RR0899	Thermal Insulating Sleeve	Yes
RR2012	Firestone Service Air Line-1/4in	
RR2360	Air Bag Fitting Kit-1/4in	Yes
RR3025	Union Air Fitting Tee-1/4in	
RR3031	Elbow Connector-1/4in 25pk	
RR3046	Male Connector-1/4in	Yes
RR3066	Compressor Tee Air Fitting-1/8in-1/4in	
RR3077	Bail Clamp	Yes
RR3079	Union Air Line-1/4in	
RR3098	Inflation Valve-1/4in	
RR3128	Elbow Connector-1/8in-1/4in 25pk	Yes
RR5086	Bracket Strap	Yes
RR5092	Lower Bracket	Yes
RR5260	Round Plate	Yes
RR5376	Upper Brackets	Yes
RR5428	Fuel Line Bracket	Yes
RR9016	Firestone Pressure Switch-1/8in	
RR9054	Pressure Sender	Yes
RR9074	Pneumatic Pad Switch	Yes
RR9129	Compressor Air Filter	
RR9193	Pressure Switch-1/8in 100-150 PSI	
RR9311	Compressor Check Valve	Yes
RR9350	Air Filter Kit	Yes
RR9399	Check Valve-1/8in	Yes
RR9401	Sealed Pressure Switch	Yes
RRA217602535	Hardware	Yes

Cargo Control

Suspension Enhancement

Air Bags

Firestone Replacement Bags



Item Number	Description	SO
RR0335	Replacement Bag	
RR2370	Spacer Kit 4in Spring	Yes
RR2371	Spacer Kit 4in Spring	Yes
RR5090	Upper Bracket Ford F350	Yes
RR5379	Saddle Bracket	Yes
RR5380	Lower Bracket	Yes
RR5463	Lower Bracket	Yes
RR5557	Spacer long	Yes
RR5558	Spacer short	Yes
RR5577	Bracket Tongue left	Yes
RR5578	Bracket Tongue right	Yes
RR5717	Bracket	Yes
RR6000	Replacement Air Bag	Yes
RR6003	Replacement Air Bag	Yes
RR6007	Replacement Air Bag	Yes
RR6013	Replacement Bag	Yes
RR6401	Replacement Air Bag	
RR6760	Replacement Air Bag	Yes
RR6762	Replacement Air Bag	Yes
RR6776	Replacement Air Bag	Yes
RR6781	Replacement Air Bag	
RR6869	Replacement Air Bag	Yes
RR6905	Convolutd Double Bag	Yes
RR7012	Replacement Air Bag	Yes
RR7076	Air Spring 70mm	Yes
RR7304	Replacement Bag	Yes
RR7325	Air Spring 26c	Yes
RR7668	Replacement Air Bag	Yes
RR7703	Replacement Air Bag	Yes
RR9000	Replacement Air Bag	Yes
RR9001	Replacement Air Bag	Yes
RR9002	Replacement Air Bag	Yes
W01-358-4503	Replacement Bag	Yes

Cargo Control

Suspension Enhancement Air Bags Switches & Pressure Gauge

Item Number	Description	SO
RR2145	Dual Pneumatic Gauge	
RR2149	Single Pneumatic Gauge	
RR2188	Dual Electric Panel Kit	Yes
RR2191	Single Electric Pneumatic Gauge	
RR2196	Air Pressure Monitoring Gauge	Yes
RR2229	Electric Paddle Panel Kit	Yes
RR2241	Replacement Gauge	Yes
RR2260	Dual Electric Gauge	Yes
RR2489	Wireless Air Command	
RR2490	Single Digital Gauge Kit	Yes
RR2491	Dual Digital Gauge Kit	
RR9039	Electric Pneumatic Switch	
RR9992	Pressure Gauge 1.5	Yes
RR9994	Pressure Gauge 2.5	



Cargo Control

Suspension Enhancement Firestone Ride-Rite Firestone Replacement Bag Chart

Application Guide by Kit

MAKE	MODEL	YEAR	FRONT REAR
1003 - replacement bag # 7210			
Chevrolet	Suburban 2500 (4x2, 4x4)	00-09	Front
Chevrolet/GMC	C-1500 HD Silverado, Sierra (4x2, 4x4)	05-06	Front
Chevrolet/GMC	C-1500 HD Silverado, Sierra (4x2, 4x4)	01-03	Front
Chevrolet/GMC	C-2500 HD, C-3500 HD (4x2, 4x4)	01-10	Front
Chevrolet/GMC	C-3500 HD, Silverado, Sierra (4x2, 4x4)	01-10	Front
GMC	Denali XL 2500 (4x2, 4x4)	00-09	Front
GMC	Yukon XL 2500 (4x2, 4x4)	00-09	Front
1004 - replacement bag # 7215			
Dodge	Ram 2500 (4x4 only)	03-10	Front
Dodge	Ram 3500 (4x4 only)	03-10	Front
1005 - replacement bag # 7217			
Chrysler	Town and Country	96-07	Rear
Dodge	Caravan, Grand Caravan	96-07	Rear
2025 - replacement bag # 6781			
Chevrolet/GMC	C & K-1500 (4x2, 4x4)	88-98	Rear
Chevrolet/GMC	C & K-2500 (4x2, 4x4) (with rear drum brakes)	99-00	Rear
Chevrolet/GMC	C & K-2500 (4x2, 4x4)	88-98	Rear
Chevrolet/GMC	C & K-3500 (4x2, 4x4)	88-00	Rear
2061 - replacement bag # 6764			
Ford	E-250	07-08	Rear
Ford	E33 (with front coil springs)	92-96	Rear
Ford	E-350 (with dual rear wheels)	92-11	Rear
2071 - replacement bag # 6781			
Chevrolet/GMC	C & R 10, 1500 (4x2 only)	73-87	Rear
Chevrolet/GMC	C & R-20 (4x2 only)	73-87	Rear
Chevrolet/GMC	C & R-30, C & R-3500 (4x2 only)	73-87	Rear
Dodge	D & W 100, 150, Ram 1500 (4x2, 4x4)	69-01	Rear
Dodge	D & W 200, 250, Ram 2500 (4x2, 4x4)	69-02	Rear
Dodge	D & W 300, 350, Ram 3500 (4x2, 4x4)	69-02	Rear
Ford	F-100, 150 (4x2, 4x4)	69-96	Rear
Ford	F-250 under 8500 GVWR (4x2, 4x4)	69-96	Rear
Ford	F-250 (4x2, 4x4) (without factory inbed hitch)	11	Rear
Ford	F-250 over 8500 GVWR (4x2, 4x4)	63-10	Rear
Ford	F-350 (4x2, 4x4) (without factory inbed hitch)	11	Rear
Ford	F-350	63-10	Rear
Freightliner	"M" and "X" chassis (not XC21) (below 22,000 GVWR)	94-98	Rear
2101 - replacement bag # 6781			
Cadillac	Escalade (4X2, 4X4) (4 door only)	99-00	Rear
Chevrolet	Suburban 1500 (4x2, 4x4)	92-99	Rear
Chevrolet	Suburban 2500 (4x2, 4x4)	92-99	Rear
Chevrolet	Tahoe (4x2, 4x4) (4-door only)	95-99	Rear
GMC	Yukon 1500 (4x2, 4x4) (4-door only)	95-99	Rear
2170 - replacement bag # 6781			
Ford	F53 (16,000 to 22,000 GVWR) (not Thor m/h)	08-10	Rear
Ford	F53 (16,000, 18,000 GVWR) (not Thor m/h)	99-07	Rear
Ford	F59	11	Rear
2172 - replacement bag # 9001			
Ford	Ranger (4x2, 4x4) (not for use with composite leaf) (not SuperCab 4x4 with 6' bed)	83-09	Rear
2190 - replacement bag # 6781			
Chevrolet/GMC	C-1500 HD Silverado, Sierra (4x2, 4x4)	05-06	Rear
Chevrolet/GMC	C-1500 HD Silverado, Sierra (4x2, 4x4)	01-03	Rear
Chevrolet/GMC	C-2500, Silverado, Sierra (4x2, 4x4) (not HD)	99-05	Rear
2245 - replacement bag # 6781			

Cargo Control

Suspension Enhancement Firestone Ride-Rite Firestone Replacement Bag Chart Application Guide by Kit

MAKE	MODEL	YEAR	FRONT REAR
Ford	F-350 (4x2, 4x4)	08-10	Rear
2525 - replacement bag # 6781			
Ford	F-150 (4x2, 4x4)	09-11	Rear
Lincoln	Mark LT (4x2, 4x4)	09	Rear
4100 - replacement bag # 6000			
Chevrolet	Blazer (4x2 only) (full size)	73-91	Front
Chevrolet/GMC	C & R 10, 1500 (4x2 only)	73-87	Front
Chevrolet/GMC	C & R-20 (4x2 only)	73-87	Front
Chevrolet/GMC	C-30 (4X2 only)	67-87	Front
Chevrolet/GMC	G-10, G-20, G-30, G-1500, G-2500, G-3500	70-95	Front
Chevrolet/GMC	GP-30 HD (cutaway) (14,500 GVWR)	93-96	Front
Chevrolet/GMC	P-30	93-99	Front
Chevrolet/GMC	Suburban 1500, 2500 (4x2 only)	73-91	Front
GMC	Jimmy (4x2 only) (full size)	73-91	Front
4101 - replacement bag # 6002			
Ford	E-150	75-11	Front
Ford	E-250	75-11	Front
Ford	E-350	75-11	Front
Ford	E-450	96-11	Front
Ford	F-250 under 8500 GVWR (4x2 only)	69-96	Front
Ford	F-250 over 8500 GVWR (4x2 only)	84-11	Front
Ford	F-350 (4x2 only)	06-11	Front
Ford	F-350 (4x2 only)	70-04	Front
Ford	F-450 (4x2 only)	08-11	Front
Ford	E33 (with front coil springs)	86-91	Front
Ford	E33 (with front coil springs)	92-96	Front
4106 - replacement bag # 6015			
Buick	Riviera	79-85	Rear
Cadillac	El Dorado	79-85	Rear
Cadillac	Seville	80-85	Rear
Ford	Thunderbird	80-88	Rear
Ford	Windstar	98-03	Rear
Isuzu	Trooper	92-97	Rear
Lincoln	Continental (with rear coil springs)	82-88	Rear
Lincoln	Mark IV (with rear coil springs)	84-87	Rear
Mercury	Cougar	80-88	Rear
Nissan	Pathfinder (4x2, 4x4)	87-95	Rear
Oldsmobile	Bravada (4x2, 4x4) (with rear coil springs)	02-05	Rear
Oldsmobile	Toronado	79-85	Rear
4108 - replacement bag # 6003			
Cadillac	Escalade, ESV, EXT (4X2, 4X4)	02-10	Rear
Chevrolet	Avalanche 1500 (4x2, 4x4)	02-10	Rear
Chevrolet	Suburban 1500 (4x2, 4x4)	00-10	Rear
Chevrolet	Tahoe (4x2, 4x4)	00-10	Rear
Chevrolet	Trailblazer (4x2, 4x4)	02-09	Rear
Ford	Country Squire	83-97	Rear
Ford	Crown Victoria	83-97	Rear
GMC	Envoy (4x2, 4x4) (with rear coil springs)	02-09	Rear
GMC	Yukon 1500 (4x2, 4x4)	00-10	Rear
Hummer	H2, H2 SUT (with rear coil springs)	03-09	Rear
Lincoln	Towncar	80-89	Rear
Mercury	Colony Park	83-97	Rear
Mercury	Grand Marquis	83-97	Rear
4118 - replacement bag # 4118			
Infiniti	FX45 (4x2, 4x4)	03-08	Rear
Jeep	Grand Cherokee (4x2, 4x4) (not "up country")	92-98	Rear

Cargo Control

Suspension Enhancement Hellwig Application List

Hellwig Products available by special order only.

Hellwig
PRODUCTS.COM

LOAD AND SWAY CONTROL
SWAY BARS · AIR SPRINGS · LEAF SPRINGS · FASTRACK

FAST RACK **Hellwig AIR** **Hellwig**

WWW.HELLWIGPRODUCTS.COM

66

Cargo Control & Accessories

Cargo Control

Suspension Enhancement Hellwig Application List

Hellwig Products available by special order only.

EZ-990



Mounts under factory axle plate

Amazing load capacity for the price!

2000 lbs level load capacity

LIFETIME WARRANTY

**INCREASE SPRING RATE
& STABILITY**

Can be adjusted independently for uneven side to side loads

Mounts under factory axle u-bolt plates

Step bracket style also available

EZ-990



Step bracket style-use to avoid disassembly of factory axle plate & u-bolts



Step bracket style

HELLWIG AIR™

Hellwig  **air**
PRODUCTS.COM SUSPENSION

Air Suspension

Better handling and control under heavily loaded conditions

Maximize safe load carrying capacity, stability and ride quality

Superior ride quality of this unit softens typical loaded ride conditions by transferring load from the vehicles leaf spring to the Hellwig Air Spring

Simple installation for years of heavy duty control

Each kit is designed to maximize safe load carrying capacity

Longer stroke (less pressure for softer ride)

Complete with double convoluted heavy duty air springs

Lifetime warranty on Hellwig bracketery



*Heavy duty powder coated brackets

**AIR
SUSPENSION**

Cargo Control

Suspension Enhancement SuperSpring Application List

SuperSprings™



Locate the **SuperSprings** part number for your vehicle in the chart below or from the "Find your Spring" pull down menu on the home page.

Where a Mounting Kit is required, remember to order part number MTKT separately.

If your vehicle has rear leaf springs but is not listed on this site, please contact our [tech support](#) line for additional applications.

SuperSprings enhance load carrying capacity, handling and towing.
Do not load any vehicle beyond the manufacturer's gross vehicle weight rating.

See All In One Application Guide For Fit List

Cargo Control

Suspension Enhancement Timbren Application List



- Reduce Suspension Sag
- Improve Roll Stability
- Cushion Road Shock
- Improve Handling
- Easy To Install
- Maintenance Free
- Lifetime Warranty

Timbren kits are available for both front and rear suspensions.

Timbren SES - Suspension Enhancement Systems provide protection against overloading, road shock, bottoming out, sway and broken springs. Front axle kits prevent front end nose diving. Together, these features provide a smooth, level ride, even with heavy loads.

Today's on and off road vehicles are well engineered with fine suspensions, built to do the job for which they were designed. However, many vehicles are overloaded, or drivers find themselves on bad roads or operating under unusual conditions where the suspension needs help. Timbren's Aeon Hollow Rubber Springs were designed to meet these needs. Timbren SES kits help to eliminate sway and bottoming out, get rid of axle hop, and give an even, level, stable ride, both while loaded and unloaded. Timbren SES kits are simple to install and require no alteration to your present suspension.

Most Timbren kits are simple to install and do not require drilling.

We've provided access to the installation instructions for every Timbren kit we offer. Simply find your vehicle in our application guide above, and you will be shown a link that will take you to the instructions. The typical Timbren installation goes something like this:

- Raise the vehicle allowing the axle to hang free
- Remove the wheels for greater access to the suspension
- Remove the OEM bump stop
- Assemble the Aeon rubber springs and brackets as shown on the installation instruction sheet
- Reinstall the wheels and lower the vehicle
- Check for correct positioning and clearances

One of the great benefits of Timbren helper springs is that there is no maintenance to perform once installed. Timbren helper springs are designed to last the life of your vehicle.

See All In One Application Guide For Fit List

Cargo Control

Winches & Accessories Electric Winches



A: Mfg.

Item Number	Description	SO	A
89-24429	Solenoid Assembly Type 6	Yes	SuperW
KT2000	Trakker Electric Winch 2K	Yes	Keeper
KT2500C	Camo Electric Winch 2.5K	Yes	Keeper
KT3000C	Camo Electric Winch 3K	Yes	Keeper
KT4000C	Electric Winch w/Fairlead 4K		Keeper
KTA14103	Handheld Remote	Yes	Keeper
SW03000	Electric Winch w/Fairlead 1K		SuperW
SW1120149	Winch In a Bag		SuperW
SW1125220	Winch Terra25 Single Line Pull		SuperW
SW1125230	Winch Terra25 Single Line Pull		SuperW
SW1135220	Winch Terra35 Single Line Pull		SuperW
SW1135230	Winch Terra35 Single Line Pull		SuperW
SW1145220	Winch Terra45 Single Line Pull		SuperW
SW1145230	Winch Terra45 Single Line Pull		SuperW
SW1510200	Winch LP10000 Single Line Pull		SuperW
SW1585202	Winch LP8500 Gen II 12 VDC		SuperW
SW1618200	Winch Talon 18.0 12v	Yes	SuperW
SW1695210	Winch Talon 9.5i 12v	Yes	SuperW
SW1698201	Winch Rock 98 12v	Yes	SuperW
SW2302305	Winch Cover for EPI's		SuperW
SW90-25048-01	Winch Socket Assembly EP	Yes	SuperW
SW90-30511	Roller Fairlead EPI 9.0	Yes	SuperW
SW90-33472	Winch Cable EP12	Yes	SuperW
SWEPI12.5	Electric Winch w/Fairlead 12.5K	Yes	SuperW
SWEPI16.5	Electric Winch w/Fairlead 16.5K	Yes	SuperW
SWEPI6.0	High Performance Winch	Yes	SuperW
SWEPI9	High Performance Winch 9K		SuperW
SWGP2300	Electric Winch w/Fairlead 2.3K		SuperW
SWGP3000	Electric Winch w/Fairlead 3K		SuperW
SWLT2000	ATV Electric Winch 2K	Yes	SuperW
SWS4000	Electric Winch w/Fairlead 4K		SuperW
SWS5000	Electric Winch w/Fairlead 5k		SuperW

Cargo Control & Accessories

Cargo Control

Winches & Accessories Electric Winches

Superwinch ATV Mount Kits include all mounting brackets, hardware and installation instructions

ARTIC CAT	Year	SW Part #'s
700 4x4 (ALL including V2, H1)	07-08	SW2202873
650 4x4 (ALL including V2, H1, TRV, TBX)	05-08	SW2202873
650 4x4 V2	04	SW2202380
500 4x4 (ALL Except 05 TRV)	05-08	SW2202873
500 4x4 TRV 2-UP	05	SW2202380
500 4x4 (ALL Including TBX/TRV)	02-04	SW2202380
500 4x4 (ALL)	99-01	SW2202360
454 4x4 BEAR CAT	96-98	SW2202360
400 4x4 (ALL Including TBX/TRV)	06-08	SW2202873
400 4x4 (ALL Including TBX/TRV)	02-05	SW2202380
400 4x4	98-01	SW2202360
375 4x4 AUTOMATIC	02	SW2202380
300 4x4	02-05	SW2202380
300 4x4	98-01	SW2202360
250 2x4 / 4x4	01	SW2202360
650 & 700 PROWLER 4x4 or H1 XTX (ALSO ACCEPTS UTV400)*	06-08	SW2202892

CAN-AM/Bombardier	Year	SW Part #'s
800 OUTLANDER 4X4	06-08	SW2202893
800 OUTLANDER MAX 2-UP	06-08	SW2202893
660 OUTLANDER 4X4	06-08	SW2202893
660 OUTLANDER MAX 2-UP	06-08	SW2202893
600 OUTLANDER MAX 4X4	07-08	SW2202893
500 OUTLANDER 4X4	07-08	SW2202893
400 OUTLANDER MAX 2-UP	04-08	SW2202866
400 OUTLANDER 4X4	03-08	SW2202866
330 OUTLANDER 4X4	04-06	SW2202866

HONDA	Year	SW Part #'s
TRX 650/680 RINCON (ALL)	03-08	SW2202867
TRX 500 FOREMAN RUBICON (ALL)	07-08	SW2202878
TRX 500 FOREMAN E.S.	05-06	SW2202877
TRX 500 FOREMAN RUBICON & GPSCAPE	05-06	SW2202879
TRX 500 FOREMAN RUBICON (ALL)	01-04	SW2202379
TRX 450 FOREMAN 4X4 (ALL)	98-04	SW2202381
TRX 420 RANCHER (ALL)	07-08	SW2202889
TRX 400 RANCHER (ALL)	04-07	SW2202375
TRX 400 4X4	95-01	SW2202381
TRX 350 RANCHER (ALL)	00-06	SW2202375
TRX 300 2X4 / 4X4	93-00	SW2202352

KAWASAKI	Year	SW Part #'s
700 PRAIRIE 4x4	04-06	SW2202382
650 BRUTE FORCE 4X4 STRAIGHT AXLE	05	SW2202875
KVF 650 PRAIRIE 4X4	02-03	SW2202382
350 PRAIRIE (ALL)	03-08	SW2202846
3010 MULE DIESEL (4-DOOR)	05-07	SW2202868
KAF 650 MULE 4X4 04	04	SW2202868
610 MULE (ALSO ACCEPTS UTV400)*	05-07	SW2202882
KAF 620 MULE 4X4 03-05	03-05	SW2202868
750 TERYX 4X4	08	SW2202891

* Kit fits UTV400 4 hole mount pattern 3.0" x 6.66" (76mm x 169mm)

Mounting kits are built strong and easy to install.



Never use a winch to lift or move people.
Never use a winch as an overhead hoist or to suspend a load.

POLARIS	Year	SW Part #'s
SPORTSMAN 800 4X4 05-08	05-08	SW2202863
800 SPORTSMAN 800 X2 & TOURING TWO-UP	07-08	SW2202863
700 SPORTSMAN 4X4 X2 TWO-UP	08	SW2202863
700 SPORTSMAN 4X4	02-07	SW2202863
600 SPORTSMAN 4X4	03-05	SW2202863
600 SPORTSMAN X2 & TOURING TWO-UP	07-08	SW2202863
500 SPORTSMAN 4X4 X2 TWO-UP	06	SW2202867
500 SPORTSMAN 6X6	00-08	SW2202872
500 ATP O. 4X4	04-05	SW2202872
500 SPORTSMAN 4X4	04-08	SW2202863
500 SPORTSMAN 4X4	96-03	SW2202872
500 SPORTSMAN 6X6	00-07	SW2202872
500 MAGNUM/EXPLORER 4X4	97-00	SW2202872
465 DIESEL 4X4	99-00	SW2202872
SPORTSMAN 450 4X4	06-07	SW2202863
425 XPEDITION 4X4	00	SW2202872
400 SPORTSMAN 4X4	04-05	SW2202864
400 SPORTSMAN 4X4	01-03	SW2202872
400 XPLOER 4X4	95-02	SW2202872
335 SPORTSMAN 4X4	98-00	SW2202872
330 ATP 4X4	04-05	SW2202872
325/330 MAGNUM 4X4	00-04	SW2202872
300 XPLOER 4X4	96-99	SW2202872
RANGERS (ALL) (ALSO ACCEPTS UTV400)*	03-08	SW2202871
RANGER 2009 (NEW KIT COMING) (ALSO ACCEPTS UTV400)*	09	SW2202894
RAZOR	08	SW2202890

SUZUKI	Year	SW Part #'s
750 KING QUAD	08-09	SW2202874
700 TWIN PEAKS	04-05	SW2202382
700 KING QUAD	05-07	SW2202874
600 WINSON 4X4 (ALL)	02-07	SW2202387
400 KING QUAD	08-09	SW2202895
400 EIGER (ALL)	02-07	SW2202387
450 KING QUAD	07-08	SW2202874
620 4X4 Q.U.V.	05	SW2202868

YAMAHA	Year	SW Part #'s
700 GRIZZLY 4X4 (ALL)	07-08	SW2202883
660 GRIZZLY 4X4	02-08	SW2202383
550 GRIZZLY (ALL)	09	SW2202883
450 GRIZZLY 4X4	07-08	SW2202855
450 KODIAK 4X4	03-06	SW2202855
400 BIG BEAR 4X4	07-09	SW2202866
400 BIG BEAR 4X4	00-06	SW2202377
400 KODIAK 4X4	03-05	SW2202855
400 GRIZZLY 4X4	07	SW2202855
350 GRIZZLY 4X4	07-08	SW2202855
350 BRUIN 350 4X4	04-06	SW2202855
WOLVERINE 350 2X4	07	SW2202896
WOLVERINE 350 4X4	95-05	SW2202365
RHINO (ALL) (ALSO ACCEPTS UTV400)*	04-09	SW2202888



Cargo Control & Accessories

Cargo Control

Winches & Accessories

Winches

Manual Hand Winch



CU29403 - CU29404



TTW1400



TTW2000



TTW2500



CU29405 - CU29409



TTW800



TTWB800



TTWB1600



A: Capacity **B:** Drum Capacity **C:** Gear Ratio **D:** Speed **E:** Reversible

Item Number	Description	Color	A	B	C	D	E
CU29403	Manual Winch	Zinc	900lbs	3/4in	3.1:1	1	Yes
CU29404	Manual Winch	Zinc	1200lbs	3/4in	4.1:1	1	Yes
CU29405	Manual Winch	Zinc	1400lbs	3/4in	4.1:1	1	Yes
CU29407	Manual Winch	Zinc	1700lbs	1in	5.1:1	1	Yes
CU29408	Manual Winch	Zinc	1900lbs	1in	5.1:1	1	Yes
CU29409	Manual Winch	Zinc	2100lbs	1in	5.1:1	1	Yes
TTW1400	Boat Winch	Zinc	1400lbs	3/16inx36ft	4:1	1	Yes
TTW2000	Boat Winch	Zinc	2000lbs	3/16inx36ft	4:1/8:1	2	Yes
TTW2500	Boat Winch	Zinc	2500lbs	7/32inx33ft	4:1/8:1	2	Yes
TTW800	Boat Winch	Zinc	800lbs	5/32inx36ft	3.2:1	1	No
TTWB1600	Brake Boat Winch	Black	1600lbs	7/32inx30ft	4.4:1	----	----
TTWB800	Brake Boat Winch	Black	800lbs	15/32inx50ft	3.5:1	----	----

Tuff-Tow Boat Winches

- Heavy duty bracket for added strength
- Machined heavy duty gears for easier cranking and longer life
- Reversible ratchet to allow cranking cable onto the drum in either direction
- Strap Capacity 2"x23"

Tuff-Tow Brake Boat Winches

- Perfect for grain augers, conveyors, boat lifts and more
- Self-activating automatic brake prevents heavy load from falling

Cargo Control & Accessories

Cargo Control

Winches & Accessories Fairlead



SW1560C



SW96-24509

A: Pkg Type B: MFG

Item Number	Description	SO	A	B
SW1560C	Roller Fairlead	Yes	----	SuperW
SW90-24509	Aluminum Hawse Fairlead	Yes	Pkg	SuperW

Hubs



SW400518



SW400526

A: Pkg Type B: MFG

Item Number	Description	SO	A	B
SW400518	Premium Hub	Yes	----	SuperW
SW400526	Universal Hubs 81-86 Jeep CJ	Yes	Pkg	SuperW

Mount



SW2050



SW2055

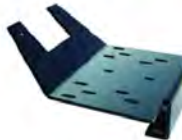

SW2202888



SW2202891



SW2231



SW2302290



SW2302287

A: Pkg Type B: MFG

Item Number	Description	SO	A	B
SW2050	Large Winch Cradle		Pkg	SuperW
SW2055	Small Winch Cradle		Pkg	SuperW
SW2202888	ATV Mount Kit		Pkg	SuperW
SW2202891	ATV Mount Kit	Yes	Pkg	SuperW
SW2231	Hawse T-Series		Pkg	SuperW
SW2302287	Plate Mount For 6K & 9K Winch		Bulk	SuperW
SW2302290	Mounting Bracket for Jeep	Yes	Pkg	SuperW

Cargo Control

Winches & Accessories

Pulley Block



SW2212A



SW2227A



SW2229A



SW7750A

A: Capacity B: Pkg Type C: MFG

Item Number	Description	A	B	C
SW2212A	Pulley Block w/Hook 12k	12K	Pkg	SuperW
SW2227A	Pulley Block 8K	8K	Pkg	SuperW
SW2229A	Pulley Block 9K	9K	Pkg	SuperW
SW7750A	Pulley Block 20K	20K	Pkg	SuperW

Recovery Strap



CU83066



SW2531

A: Width B: Length C: Capacity D: Pkg Type E: MFG

Item Number	Description	A	B	C	D	E
CU83066	Strap Vehicle Recovery	2in	30ft	18K	Bulk	Curt
SW2531	Strap Vehicle Recovery	3in	8ft	23.5K	Pkg	SuperW

Cargo Control

Winches & Accessories Remote & Solenoid



A: Pkg Type B: MFG

Item Number	Description	SO	A	B
SW06202	ATV Winch Wireless Remote		Pkg	SuperW
SW06212	ATV Winch Wireless Remote		Pkg	SuperW
SW06702	Wireless Remote Upgrade		Pkg	SuperW
SW1515A	Winch Remote		Pkg	SuperW
SW1515B	Solenoid w/Socket Kit	Yes	Pkg	SuperW
SW1520	Winch Wiring Kit Up to 5K		Pkg	SuperW
SW1551	Quick Disconnect 6-10 AWG Wire		Pkg	SuperW
SW2007	Front Wiring Kit w/5ft Lead 5K-16.5K		Pkg	SuperW
SW2008	Winch Trailer Wiring Kit 25ft 16.5K		Pkg	SuperW
SW2236	Quick Disconnect Large 2-4 AWG		Pkg	SuperW
SW2270	Remote w/Mating Socket 15ft		Pkg	SuperW
SW2271	Remote w/Mating Socket 30ft		Pkg	SuperW
SW2272	Remote Replacement Parts	Yes	Pkg	SuperW
SW2302277	Solenoid Roggle Upgrade Kit		Pkg	SuperW
SW89-32332	Circuit Breaker		Pkg	SuperW
SW98-10880	Solenoid 12V	Yes	Pkg	SuperW

Cargo Control

Winches & Accessories

Rope



305005



SW2570



SW87-42613



SW90-20515



SW90-24506



SW90-24510



T-9165000

A: Width B: Length C: Pkg Type D: Mfg.

Item Number	Description	SO	A	B	C	D
SW2570	Winch Rope Dampener		N/A	N/A	Pkg	SuperW
SW87-42613	Synthetic Rope	Yes	3/16in	50ft	Pkg	SuperW
SW90-20515	Wire Rope	Yes	21/64in	125ft	Pkg	SuperW
SW90-24506	Synthetic Rope	Yes	3/8in	80ft	Pkg	SuperW
SW90-24510	Synthetic Rope	Yes	3/8in	50ft	Pkg	SuperW
T-9165000	Truckers Tie Down Rope		3/8in	50ft	Pkg	Keeper

Tow Hook



B2799B



CU22401



CU22411



CU22420



CU22430

A: Capacity B: Width C: Length D: Pkg Type E: Mfg.

Item Number	Description	A	B	C	D
B2799B	Tow Hook	10K	----	Buyers	
CU22401	Tow Hook w/Hardware 10K	N/A	N/A	Curt	Pkg
CU22411	Tow Hook w/Hardware 10K	N/A	N/A	Curt	Pkg
CU22420	Tow Hook w/o Hardware 10K	N/A	N/A	Curt	Bulk
CU22430	Tow Hook w/o Hardware 10K	N/A	N/A	Curt	Bulk

Winch Strap



CU29007



TD46504



TD46507
TD46511



TT325



TTWS20

A: Capacity B: Width C: Length D: Pkg Type E: Mfg.

Item Number	Description	A	B	C	D	E
CU29007	Winch Strap w/Hook	4K	2in	20ft	Bulk	Curt
TD46504	Winch Strap w/Hook	3.7K	2in	20ft	Bulk	Tie Down
TD46507	Winch Cable w/Hook	4.2K	3/16in	25ft	----	Tie Down
TD46511	Winch Cable w/Hook	5.6K	7/32in	50ft	----	Tie Down
TT325	Winch Cable w/Hook	4K	3/16in	25ft	Pkg	Tuff-Tow
TTWS20	Winch Strap w/Hook	4K	2in	23ft	Pkg	Tuff-Tow

Cargo Control

Motor Cycle Chocks



SPWC
SPWS



SPWFKW



SPWFKM



WC181212

A: Length B: Width C: Height D: Mfg.

Item Number	Description	Color	SO	A	B	C	D	Extra Info
SPWC	Motorcycle Chock w/Keyhole	Chrome		12in	8-1/4in	8-1/2in	Phoenix	Hardware Separate
SPWFKM	Wheel Chock Hardware	Stainless		N/A	N/A	N/A	Phoenix	For Metal Floors
SPWFKW	Wheel Chock Hardware	Stainless		N/A	N/A	N/A	Phoenix	For Wood Floors
SPWM	Motorcycle Wheel Chock	Black	Yes	12in	8-1/4in	8-1/2in	Phoenix	Hardware Separate
SPWS	Motorcycle Chock w/Keyhole	Stainless		12in	8-1/4in	8-1/2in	Phoenix	Hardware Separate
WC181212	Motorcycle Chock Universal	Black		18in	12in	12-1/4in	Buyers	Hardware Included

Racks

Landscape Accessories

A: Mfg.

Item Number	Description	SO	A	Extra Info
3004710	Water Cooler Strap		Buyers	For LT25
3009122	Double J-Hook Hanger	Yes	Buyers	w/Steel Mounting Angle
LT10	Trimmer Rack Snap-in Style		Buyers	Holds 3 Trimmers
LT12	Trimmer Rack Snap-in Style		Buyers	Holds 3 Trimmers
LT13	Trimmer Rack Channel Style	Yes	Buyers	Holds 3 Trimmers
LT15	Multi Purpose Rack		Buyers	w/Straps
LT20	Backpack Blower Rack		Buyers	w/Spring Latch
LT22	Backpack Blower Rack		Buyers	w/Strap & Hardware
LT25	Water Cooler Rack		Buyers	----
LT30	Gas Can Holder Rack		Buyers	----
LT32	Locking Gas Can Rack	Yes	Buyers	w/Hardware
LT35	Straight Handle Tool Rack		Buyers	Holds 6 Tools
LT37	Enclosed Trailer Hand Tool Rack		Buyers	Holds 6 Tools
LT40	Trimmer Line Spool Bracket		Buyers	----
TCH10V	Vertical Traffic Cone Holder 22in		Buyers	Holds 10 18in/5 28in
TCH12V	Vertical Traffic Cone Holder 12inx11in		Buyers	Holds 28 Cones
TH24100	Gas Can Holder Rack		Toy Hauler	w/Pin & 60in Strap



LT10



LT15



TH24100



LT25



LT30



TCH10V



LT35



LT20

Cargo Control & Accessories

Cargo Control

Ramp Accessories

A: Mfg.



Item Number	Description	SO	A	Extra Info
B3002879	Torsion Ramp Spring LH		Buyers	----
B3002880	Torsion Ramp Spring RH		Buyers	----
RA-27C	Double Barrel Trailer Gate Assist	Yes	Tuff-Tow	Chain Driven
RL1912-A20	Floor Roller Conveyor		Tuff-Tow	w/Galvanized Tube

Steps Handles

A: Width B: Height C: Depth D: Mfg.



Item Number	Description	Color	SO	A	B	C	D
5232000	Retractable 2 Rung Step	Black		14-1/2in	24.5in	N/A	Buyers
AA1124	Dual Receiver Camper Step 5in Up/down	Black		27in	12in	12in	AAction
AST60	Anitskid Tape Self-Adhesive	Black		60ft	2in	N/A	Buyers
AST660	Antiskid Tape Self-Adhesive	Black		60ft	6in	N/A	Buyers
B2797BPC	Folding Safety Grab or Step	Black		N/A	N/A	N/A	Buyers
B2797SS	Folding Safety Grab or Step	Stainless	Yes	N/A	N/A	N/A	Buyers
B5230912	Cable Style Step	Black	Yes	12in	9in	1-3/8in	Buyers
B5231512	Cable Style Step	Black	Yes	15in	12in	1-3/8in	Buyers
B5231515	Cable Style Step	Black	Yes	15in	15in	4-3/4in	Buyers
BC2399	Grab Handle	Chrome		11.5in	N/A	5/8in	Buyers
BZ2797	Folding Safety Grab or Step	Zinc		4.365in	2.120in	N/A	Buyers
FS2797CH	HD Foot or Grab Step	Aluminum		N/A	N/A	N/A	Buyers
LC235453	Radius Step	----		24in	7in	8in	Lippert
LC235454	Radius Step w/2 Steps	----		24in	7in	8in	Lippert
LC257716	Radius Step	----		24in	7in	8in	Lippert
LC257717	Radius Step w/2 Steps & Skid Tape	----	Yes	24in	7in	8in	Lippert
LC270038	Radius Step w/4 Steps & Skid Tape	----	Yes	8in	7in	8in	Lippert
RS2	Retractable 2 Rung Step	Black		27in	14in	2in	Buyers
T-05680	Safety Step Rubber Tread	Black		17.5in	4in	N/A	Tuff-Tow
TH232	Portable Wheel Step	Chrome	Yes	13.5in	3in	23-1/4in	Thule
TLA7503	GlowStep w/3 Steps	Aluminum	Yes	20in	N/A	6in	Torklift
TLA7504	GlowStep w/4 Steps	Aluminum	Yes	20in	N/A	6in	Torklift
TLA7505	GlowStep w/5 Steps	Aluminum	Yes	20in	N/A	6in	Torklift

Anchors

A: Size B: Size C Mfg.



Item Number	Description	Color	SO	A	B	C
4001	Heavy Duty Retractable Anchor	Black		N/A	N/A	Erickson
B56723	Eye Bolt	Chrome		1in Eye	3/8in Shaft	Buyers
CU83060	Hide-A-Tie Rope Hook	Chrome		----	----	Curt
FSSW025	Flange Weld Type 1/4in NPT	Stainless	Yes	1.738 OD	.620 Pilot	Buyers

Cargo Control

Truck Winches Straps Track

A: Width **B:** Length **C:** Mfg.

Item Number	Description	SO	A	B	C	D
10030	Combination Ratchet Winch Bar	Yes	N/A	36in	Kinedyne	
1903005LH	Standard Weld-On Winch LH		4in	7-7/8in	Buyers	
1903030	Sliding Adjustable Winch		4in	7-7/8in	Buyers	
1903040	Sliding Track Winch		1/4in	72in	Buyers	
3606	Steel Winch Track	Yes	1/4in	6ft	Kinedyne	
3820	Standard Webbing Winch-Sliding	Yes	4in	7-21/32in	Kinedyne	
5482100	Winch Lashing	Yes	2in	5in	Buyers	
7590C	Winch Under Mount/Sliding Combo	Yes	4in	7-7/8in	PCC	Bulk
7820	Weld-On Webbing Winch	Yes	4in	7-21/32in	Kinedyne	
8430C	Sliding Trailer Winch	Yes	3-1/2in	9-3/4in	Tuff-Tow	
8430F	Sliding Trailer Winch	Yes	3-1/2in	7-7/8in	Tuff-Tow	
B1903065	Combination Winch Bar-Use w/Truck Strap Winch		N/A	40in	Buyers	
T-05530	Rack Ratchet Strap-500lbs Load Limit		1-1/2in	8ft	Keeper	
T13008	Winch Standard Comb Web/Cable	Yes	N/A	----	Kinedyne	Pkg
T41903005	Standard Weld-On Winch RH		4in	7-7/8in	Buyers	
X888Y	Yellow Strap	Yes	4in	per ft	Tuff-Tow	Bulk



Binders

A: Min Chain **B:** Max Chain **C:** Capacity **D:** Mfg.

Item Number	Description	SO	A	B	C	D	Extra Info
10036HD	Lever Load Binder	Yes	3/8in	1/2in	9.2K	Kinedyne	Lever Style
DLBR3812	Ratchet Load Binder		3/8in	1/2in	9.2K	Tuff-Tow	Domestic
DLBR5638	Ratchet Load Binder		5/16in	3/8in	5.4K	Tuff-Tow	Domestic
LB5638S	Lever Load Binder		5/16in	3/8in	5.4K	Buyers	----
LBA5638	Adjustable Lever Load Binder		5/16in	3/8in	5.4K	Kinedyne	w/Pin
LBR250	Ratchet Load Binder		1/4in	1/4in	2.6K	Tuff-Tow	----
LBR3812	Ratchet Load Binder		3/8in	1/2in	9.2K	Buyers	----
LB5638	Ratchet Load Binder		5/16in	3/8in	6.6K	Buyers	----



Cargo Control

Binders

TIE-DOWN ASSEMBLY USAGE CHART:

This chart is provided as a guide to meet the basic minimum current in service requirements of the FMCSA¹ and the DOT² published Sept 27, 2002. The following table lists the minimum number of chain assemblies required to secure a load per DOT & CVSA³. *This chart is only to be used as a reference.

*Many factors affect the proper method of cargo securement including the length and type of the cargo to be secured. Refer to the most recent revision of The Dept. of Transportation (DOT) Title 49 regulations for more complete requirements regarding the proper methods and number of tie-downs required.

SCC Chain Grade	Size (Inches)	WLL	Net weight of cargo to be secured in Lbs.							
			20,000	25,000	30,000	35,000	40,000	45,000	50,000	
Alloy Grade 80 (S8, SX8, T-80)	5/16	4,500	3	3	4	4	5	5	6	
	3/8	7,100	2	2	3	3	3	4	4	
	1/2	12,000	1	2	2	2	2	2	3	
Transport Grade 70 (S7, SX7, S-70)	1/4	3,150	4	4	5	6	7	8	8	
	5/16	4,700	3	3	4	4	5	5	6	
	3/8	6,600	2	2	3	3	4	4	4	
	1/2	11,300	1	2	2	2	2	2	3	
High Test Grade 43 (S4, SX4, S-43)	1/4	2,600	4	5	6	7	8	9	10	
	5/16	3,900	3	4	4	5	6	6	7	
	3/8	5,400	2	3	3	4	4	5	5	
	1/2	9,200	2	2	2	2	3	3	3	
Proof Coil Grade 30 (S3 SX3, S-30)	1/4	1,300	Due to the low working load limits of S-3 chain, SCC does not recommend using Proof Coil Chain for Transport tie-down or cargo securement.							
	5/16	1,900								
	3/8	2,650								
	1/2	4,500								

¹FMCSA: Federal Motor Carrier Safety Admin

²DOT: Department of Transportation

³CVSA: The Commercial Vehicle Safety Alliance

This chart is based on each tie-down secured to a trailer anchor point, traversing across or through the load and then secured to another anchor point on the trailer.

If used by securing the tie-down to the trailer anchor point and attaching it directly to an article of cargo (IE: a vehicle), the quantity of tie-downs required shall be 2 times the quantity listed in the chart above.



WARNING: Never exceed Working Load Limit as stated in catalog and on strap tags to determine the number of tie-down assemblies and/or hardware required for safe operation per federal D.O.T. FMCSA 49 CFR Parts 392-393, CCMTA and the C.V.S.A inspection criteria. Remember, all assemblies are only as strong as their weakest point, including the point of attachment.



WARNING: Never exceed Working Load Limit. Load binding systems store energy which can release suddenly, causing serious injury. Stay clear of handle, bars and other binding equipment as it could release without warning and with extreme force. Remember, assemblies are only as strong as their weakest point, including the point of attachment. **▲ These products are NOT designed or approved for overhead lifting.**

Cargo Control

Chain (Bulk)



A: Link Size B: Length C: WLL D: Breaking Strength E: Mfg.

Item Number	Description	SO	A	B	C	D	E
51670500T	Chain Transport Grade 70 Bulk	Yes	5/16in	500ft	4,700lbs	18,800lbs	Tuff-Tow
99	Chain Tensioner		N/A	N/A	N/A	N/A	Tuff-Tow
C143	Chain Proof Coil Grade 30 Bulk		1/4in	100ft	1,300lbs	5,200lbs	Tuff-Tow
C1435	Chain Proof Coil Grade 30 Bulk	Yes	1/4in	400ft	1,300lbs	5,200lbs	Tuff-Tow
C3163	Chain Proof Coil Grade 30 Bulk		3/16in	250ft	750lbs	3,200lbs	Tuff-Tow
C38363	Chain Proof Coil Grade 30 Bulk		3/8in	63ft	2,650lbs	10,600lbs	Tuff-Tow
C387	Chain Transport Grade 70 Bulk		3/8in	75ft	6,600lbs	26,400lbs	Tuff-Tow
C5163	Chain Proof Coil Grade 30 Bulk		5/16in	92ft	1,900lbs	7,600lbs	Tuff-Tow
C51635	Chain Proof Coil Grade 30 Bulk	Yes	5/16in	550ft	1,900lbs	7,600lbs	Tuff-Tow
C5167P	Chain Transport Grade 70 Bulk		5/16in	100ft	4,700lbs	18,800lbs	Tuff-Tow
CA126	Chain Transport Grade 70 Bulk		1/2in	Per ft	9,400lbs	45,200lbs	Tuff-Tow
CA250	Chain Proof Coil Grade 30 Bulk		1/4in	Per ft	1,300lbs	5,200lbs	Tuff-Tow
CA383	Chain Proof Coil Grade 30 Bulk		3/8in	Per ft	2,650lbs	10,600lbs	Tuff-Tow
CA5163	Chain Proof Coil Grade 30 Bulk		5/16in	Per ft	1,900lbs	7,600lbs	Tuff-Tow
CA5167	Chain Transport Grade 70 Bulk		5/16in	Per ft	4,700lbs	18,800lbs	Tuff-Tow
CU82105	Chain Proof Coil Grade 30 Bulk		1/4in	Per ft	1,300lbs	5,200lbs	Curt
CU82110	Chain Proof Coil Grade 30 Bulk		5/16in	Per ft	1,900lbs	7,600lbs	Curt
CU82115	Chain Proof Coil Grade 30 Bulk		3/8in	Per ft	2,650lbs	10,600lbs	Curt
CU82116	Chain Proof Coil Grade 30 Bulk		3/16in	Per ft	800lbs	3,200lbs	Curt
CU82120	Chain High Test Grade 43 Bulk		1/4in	Per ft	2,600lbs	7,800lbs	Curt
CU82125	Chain High Test Grade 43 Bulk		5/16in	Per ft	3,900lbs	11,700lbs	Curt
CU82130	Chain High Test Grade 43 Bulk		3/8in	Per ft	5,400lbs	16,200lbs	Curt
CU82135	Chain Transport Grade 70 Bulk		1/4in	Per ft	3,150lbs	12,600lbs	Curt
CU82140	Chain Transport Grade 70 Bulk		5/16in	Per ft	4,700lbs	18,800lbs	Curt
CU82145	Chain Transport Grade 70 Bulk		3/8in	Per ft	6,600lbs	26,400lbs	Curt
CU82155	Chain Transport Grade 70 Bulk		1/2in	Per ft	11,300lbs	45,200lbs	Curt
CU82158	Chain Alloy Grade 80 Bulk		1/2in	Per ft	12,000lbs	48,000lbs	Curt
CU82160	Chain Alloy Grade 80 Bulk		5/8in	Per ft	18,100lbs	72,400lbs	Curt
CU82165	Chain Proof Coil Grade 30 Bulk		5/0in	Per ft	880lbs	3,520lbs	Curt
CU82170	Chain Proof Coil Grade 30 Bulk		8/0in	Per ft	1,900lbs	7,600lbs	Curt
FE8171-1	Car Tie Down Cluster Hook		N/A	N/A	3,900lbs	15,600lbs	Kinedyne
H0116-0811	Chain Proof Coil Grade 30 Bulk	Yes	1/2in	200ft	4,500lbs	18,000lbs	Tuff-Tow
H0117-0411	Chain Proof Coil Grade 30 Bulk	Yes	1/4in	800ft	1,300lbs	5,200lbs	SCC
LBC122070	Chain Transport Grade 70 Bulk	Yes	1/2in	20ft	11,300lbs	45,200lbs	Tuff-Tow
LBCA18	Chain Anchor D-Ring/Grab Hook		3/8in	18in	5,400lbs	21,600lbs	Kinedyne

See Previous Page for Tie-Down Usage

Cargo Control

Safety Chain



S-Hook



Pear Hook



Safety Hook



Clevis Hook

A: Link Size **B:** Length **C:** WLL **D:** Breaking Strength **E:** Mfg.

Item Number	Description	A	B	C	D	E
11275	Safety Chain Grade 43 (1) Safety Hook Pkg	3/8in	35in	5,400lbs	15,000lbs	Buyers
B03835SC	Safety Chain Grade 30 (1) Safety Hook	3/8in	35in	2,650lbs	10,000lbs	Buyers
CU80010	Safety Chain Grade 30 (2) 3/8 S-Hooks Pkg	3/16in	48in	800lbs	2,000lbs	Curt
CU80011	Safety Chain Grade 30 (2) 3/8 S-Hooks Pkg	3/16in	48in	800lbs	2,000lbs	Curt
CU80020	Safety Chain Grade 30 (1) 3/8 S-Hook	3/16in	27in	800lbs	2,000lbs	Curt
CU80030	Safety Chain Grade 30 (2) 7/16 S-Hook	1/4in	48in	1,300lbs	5,000lbs	Curt
CU80031	Safety Chain Grade 30 (2) 7/16 S-Hooks Pkg	1/4in	40in	1,300lbs	5,000lbs	Curt
CU80040	Safety Chain Grade 30 (1) 7/16 S-Hook	1/4in	27in	1,300lbs	2,500lbs	Curt
CU80300	Safety Chain Grade 30 (1) 17/32 S-Hook	8/0in	27in	1,750lbs	7,000lbs	Curt
CU80301	Safety Chain Grade 30 (2) 17/32 S-Hooks	8/0in	48in	1,750lbs	7,000lbs	Curt
CU80302	Safety Chain Grade 43 (1) Safety Hook	1/4in	35in	2,600lbs	7,800lbs	Curt
CU80303	Safety Chain Grade 70 (1) Safety Hook	1/4in	35in	3,150lbs	12,600lbs	Curt
CU80304	Safety Chain Grade 70 (1) Safety Hook	5/16in	35in	4,700lbs	18,800lbs	Curt
CU80312	Safety Chain Grade 30 (1) 3/8 Latch Pear Hook	3/16in	27in	800lbs	2,000lbs	Curt
CU80313	Safety Chain Grade 30 (1) 7/16 Latch Pear Hook	1/4in	27in	1,300lbs	5,000lbs	Curt
CU80314	Safety Chain Grade 43 (1) Safety Hook	5/16in	35in	3,900lbs	11,700lbs	Curt
CU80315	Safety Chain Grade 43 (1) Safety Hook	3/8in	35in	5,400lbs	16,200lbs	Curt
CU80316	Safety Chain Grade 70 (1) Safety Hook	3/8in	35in	6,600lbs	24,000lbs	Curt
SC142430WSH	Safety Chain Grade 30 (1) Latch S-Hook	1/4in	24in	1,300lbs	5,000lbs	Tuff-Tow
SC143670WSH	Safety Chain Grade 70 (1) Safety Hook	1/4in	36in	3,150lbs	12,600lbs	Tuff-Tow
SC383670WCH	Safety Chain Grade 70 (1) Safety Hook	3/8in	36in	6,600lbs	26,400lbs	Tuff-Tow
SC5163670WCH	Safety Chain Grade 70 (1) Safety Hook	5/16in	36in	4,700lbs	18,800lbs	Tuff-Tow
TT01853	Safety Chain Grade 30 (1) Latch S-Hook	3/16in	27in	3,500lbs	----	Tuff-Tow

Cargo Control

Transport Chain



A: Link Size **B:** Length **C:** WLL **D:** Breaking Strength **E:** Mfg.

Item Number	Description	A	B	C	D	E
5261363	Transport Chain Grade 70 (2) Clevis Hooks	5/16in	20ft	4,700lbs	18,800lbs	SCC
CU80305	Transport Chain Grade 70 (2) Clevis Hooks	5/16in	14ft	4,700lbs	18,800lbs	Curt
CU80306	Transport Chain Grade 70 (2) Clevis Hooks	5/16in	16ft	4,700lbs	18,800lbs	Curt
CU80307	Transport Chain Grade 70 (2) Clevis Hooks	5/16in	20ft	4,700lbs	18,800lbs	Curt
CU80308	Transport Chain Grade 70 (2) Clevis Hooks	5/16in	25ft	4,700lbs	18,800lbs	Curt
CU80309	Transport Chain Grade 70 (2) Clevis Hooks	3/8in	14ft	6,600lbs	26,400lbs	Curt
CU80310	Transport Chain Grade 70 (2) Clevis Hooks	3/8in	16ft	6,600lbs	26,400lbs	Curt
CU80311	Transport Chain Grade 70 (2) Clevis Hooks	3/8in	20ft	6,600lbs	26,400lbs	Curt
D3820G7	Transport Chain Grade 70 (2) Clevis Hooks	3/8in	20ft	6,600lbs	26,400lbs	Tuff-Tow
D5160G7	Transport Chain Grade 70 (2) Clevis Hooks	5/16in	20ft	4,700lbs	18,800lbs	Tuff-Tow
LBC3820	Transport Chain Grade 43 (2) Clevis Hooks	3/8in	20ft	5,400lbs	16,200lbs	Tuff-Tow
LBC382070	Transport Chain Grade 70 (2) Clevis Hooks	3/8in	20ft	6,600lbs	26,400lbs	Kinedyne
LBC51616	Transport Chain Grade 70 (2) Clevis Hooks	5/16in	16ft	4,700lbs	18,800lbs	Tuff-Tow
LBC51620	Transport Chain Grade 70 (2) Clevis Hooks	5/16in	20ft	4,700lbs	18,800lbs	Kinedyne

Safety Cable



2829DATSC



7030



TD81255



TT7030

A: Length **B:** WLL **C:** Mfg.

Item Number	Description	A	B	C
2829DATSC	Safety Cable (1) Safety S-Hook	40in	5000lbs	Master
7030	Safety Cable (1) Safety Hook	36in	7000lbs	Tuff-Tow
TD81255	Safety Cable Keeper	N/A	N/A	Tie Down
TT7030	Safety Cable (1) Safety Hook	36in	5000lbs	Tuff-Tow

Cargo Control

Clevis & Shackles



B2409B & B2409C



BS34 & BS58



DC375

A: Link Size **B:** Length **C:** WLL **D:** Mfg.

Item Number	Description	A	B	C	D
B2409B	Double Clevis Link	5/16in	N/A	3900lbs	Buyers
B2409C	Double Clevis Link	3/8in	N/A	5400lbs	Buyers
BS34	Bow Shackles	3/4in	1.06in	6500lbs	Tuff-Tow
BS58	Bow Shackles	5/8in	1.06in	6500lbs	SCC
DC375	Double Clevis Link	3/8in	N/A	5400lbs	Buyers

Quick Link

A: Link Size **B:** WLL **C:** Mfg.



Item Number	Description	A	B	C
1639	Quick Link	1/8in	220lbs	Tuff-Tow
1640	Quick Link	3/16in	660lbs	Tuff-Tow
1643	Quick Link	1/4in	880lbs	Tuff-Tow
2529	Quick Link	5/16in	1760lbs	Tuff-Tow
2530	Quick Link	3/8in	2200lbs	Tuff-Tow
2531	Quick Link	1/2in	3300lbs	Tuff-Tow
CU82610	Quick Link	1/4in	220lbs	Curt
CU82611	Quick Link (1) Pkg	1/4in	220lbs	Curt
CU82900	Quick Link	5/16in	440lbs	Curt
CU82901	Quick Link (1) Pkg	5/16in	440lbs	Curt
CU82930	Quick Link	3/8in	660lbs	Curt
CU82931	Quick Link	7/16in	880lbs	Curt
CU82932	Quick Link	1/2in	1100lbs	Curt
CU82933	Quick Link (1) Pkg	3/8in	660lbs	Curt
TTQL38	Quick Link (2) Pkg	3/8in	660lbs	Tuff-Tow
TTQL516	Quick Link (2) Pkg	5/16in	440lbs	Tuff-Tow

Cargo Control

Grab Hooks



B2409W375



Clevis Hook



Clevis Hook Yel Zinc

A:Chain Size B:Length C:Opening D:Working Load(GTWR) E:Mount Type F:MFG

Item Number	Description	Color	A	B	C	D	E	F	Extra Info
B2408W	Forged Grab Hook Weld On Grade 43		5/16in	----	----	3900lbs	Weld	Buyers	Each
B2409W375	Forged Grab Hook Weld On Grade 70	Raw	3/8in	2.99in	.52in	6600lbs	Weld	Buyers	Each
CU81330	Clevis Hook Grade 43	Zinc	1/4in	N/A	N/A	2600lbs	Clevis	Curt	Bulk
CU81340	Clevis Hook Grade 43	Zinc	5/16in	N/A	N/A	3900lbs	Clevis	Curt	Bulk
CU81350	Clevis Hook Grade 43	Zinc	3/8in	N/A	N/A	5400lbs	Clevis	Curt	Bulk
CU81438	Clevis Hook Grade 70	Zinc	3/8in	N/A	N/A	6600lbs	Clevis	Curt	Bulk
LBH1/4	Clevis Hook Grade 70	Yel Zinc	1/4in	1.97in	.40in	3600lbs	Clevis	Tuff-Tow	Each
LBH3/8	Clevis Hook Grade 70	Yel Zinc	3/8in	2.63in	.50in	7500lbs	Clevis	Tuff-Tow	Each
LBH5/16	Clevis Hook Grade 70	Yel Zinc	5/16in	2.26in	.44in	5400lbs	Clevis	Tuff-Tow	Each

Cargo Control

J-Hook

A:Chain Size B:Length C:Mounting Type D:Mfg.



Weld-On



Bolt-On

Item Number	Description	Color	A	B	C	D	Extra Info
B2447	Tarp Hook	Zinc	3/8in	3.250in	Bolt On	Tuff-Tow	Each
B2447NHP	Tarp Hook	Raw	3/8in	3.250in	Weld On	Buyers	Each
B2447WAL	Weld-On Tarp Hook	Aluminum	----	3.250in	Weld On	Buyers	Each
RH1/2	Rope Hook	Raw	1/2in	N/A	Weld On	Tuff-Tow	Each
RH3/4	Rope Hook	Raw	3/4in	N/A	Weld On	Tuff-Tow	Each
RH5/8	Rope Hook	Raw	5/8in	N/A	Weld On	Tuff-Tow	Each
TSH9225	Tarp Hook	Zinc	.175in	2.50in	Tarp Strap	Buyers	Each

Hook Accessories



09090



09094



Joining Link



Replacement Latch

A:Chain Size B:Opening C:Mfg.

Item Number	Description	Color	A	B	C	Extra Info
09090	Horseshoe Rope Cleat-2pk	Chrome	----	----	Erickson	Pkgd
09094	Hide-A-Hook-2pk	Chrome	----	----	Erickson	Pkgd
CU81999	Latch Repair Kit	Zinc	N/A	N/A	Curt	Bulk
CU82940	Joining Link	Raw	9/0in	N/A	Curt	Bulk
CU82942	Joining Link	Raw	7/16in	N/A	Curt	Bulk
CU82943	Joining Link	Zinc	9/0in	N/A	Curt	Bulk
CU82944	Joining Link	Zinc	7/16in	N/A	Curt	Bulk
H7795-0511	Latch Kit for Safety Hook	Zinc	N/A	5/16in	Tuff-Tow	fits J-55
H7795-0611	Latch Kit for Safety Hook	Zinc	N/A	3/8in	Tuff-Tow	fits J-56
H7795-0811	Latch Kit for Safety Hook	Zinc	N/A	1/2in	Tuff-Tow	fits J-57
LK3TON	Latch Kit for Safety Hook	Raw	N/A	1/2in	Tuff-Tow	Each

Cargo Control

Safety Hooks



Eye



Clevis

A:Chain Size B:Length C:Opening D:Working Load(GTWR) E:Type F:Safety Latch G:Mount Type H:MFG

Item Number	Description	Color	A	B	C	D	E	F	G	H	Extra Info
2255	Eye Slip Hook w/Latch	Zinc	1/4in	2.56in	.75in	1950lbs	Safety	Latch	Eye	Tuff-Tow	Each
CU81360	Snap Hook	Zinc	5/8in	N/A	N/A	N/A	Snap	Latch	Eye	Curt	Bulk
CU81550	Clevis Safety Hook Grade 43	Zinc	5/16in	N/A	3/4in	14000lbs	Safety	Latch	Clevis	Curt	Bulk
CU81900	Clevis Safety Hook Grade 43	Zinc	1/4in	N/A	1/2in	7800lbs	Safety	Latch	Clevis	Curt	Bulk
CU81910	Clevis Safety Hook Grade 43	Zinc	1/2in	N/A	1-1/4in	35000lbs	Safety	Latch	Clevis	Curt	Bulk
CU81920	Clevis Safety Hook Grade 80	Zinc	5/8in	N/A	1-1/4in	65000lbs	Safety	Latch	Clevis	Curt	Bulk
CU81940	Clevis Safety Hook Grade 70	Zinc	1/4in	N/A	1/2in	12600lbs	Safety	Latch	Clevis	Curt	Bulk
CU81950	Clevis Safety Hook Grade 70	Zinc	5/16in	N/A	3/4in	18000lbs	Safety	Latch	Clevis	Curt	Bulk
CU81960	Clevis Safety Hook Grade 70	Zinc	3/8in	N/A	1in	24000lbs	Safety	Latch	Clevis	Curt	Bulk
CU81970	Clevis Safety Hook Grade 80	Zinc	7/16in	N/A	1-1/3in	40000lbs	Safety	Latch	Clevis	Curt	Bulk
CU81980	Clevis Safety Hook Grade 80	Zinc	1/2in	N/A	1-1/4in	48000lbs	Safety	Latch	Clevis	Curt	Bulk
J-54	Clevis Safety Hook Grade 43	Zinc	1/4in	2.56in	.75in	1950lbs	Safety	Latch	Clevis	Tuff-Tow	Each
J-55	Clevis Safety Hook Grade 43	Zinc	5/16in	2.88in	.93in	2875lbs	Safety	Latch	Clevis	Tuff-Tow	Each
J-56	Clevis Safety Hook Grade 43	Zinc	3/8in	3.25in	1.41in	4000lbs	Safety	Latch	Clevis	Tuff-Tow	Each
J-57	Clevis Safety Hook Grade 70	Yel Zinc	1/2in	4.00in	1.42in	9000lbs	Safety	Latch	Clevis	Tuff-Tow	Each
TTCH14	Clevis Safety Hook Grade 43 (2) Pkg	Zinc	1/4in	2.56in	.75in	1950lbs	Safety	Latch	Clevis	Tuff-Tow	2Pk
TTCH38	Clevis Safety Hook Grade 43 (2) Pkg	Zinc	3/8in	3.25in	1.41in	4000lbs	Safety	Latch	Clevis	Tuff-Tow	2Pk
TTCH516	Clevis Safety Hook Grade 43 (2) Pkg	Zinc	5/16in	2.88in	.93in	2875lbs	Safety	Latch	Clevis	Tuff-Tow	2Pk

Snap Hooks



Pearl



Crimp

A:Chain Size B:Length C:Opening D:Working Load(GTWR) E:Type F:Safety Latch G:Mount Type H:MFG

Item Number	Description	Color	A	B	C	D	E	F	G	H	Extra Info
CU81261	Snap Hook With Latch (1) Pkg	Zinc	3/8in	N/A	N/A	2000lbs	Snap	Latch	Pearl	Curt	Pkg Ea.
CU81266	Snap Hook With Latch	Zinc	3/8in	N/A	N/A	2000lbs	Snap	Latch	Pearl	Curt	Bulk
CU81271	Snap Hook With Latch (1) Pkg	Zinc	7/16in	N/A	N/A	5000lbs	S-Hook	Latch	Pearl	Curt	Pkg Ea.
CU81277	Snap Hook With Latch	Zinc	7/16in	N/A	N/A	5000lbs	Snap	Latch	Pearl	Curt	Bulk
CU81281	Snap Hook With Latch (1) Pkg	Zinc	9/16in	N/A	N/A	5000lbs	S-Hook	Latch	Pearl	Curt	Pkg Ea.
CU81288	Snap Hook With Latch	Zinc	9/16in	N/A	N/A	5000lbs	Snap	Latch	Pearl	Curt	Bulk
H6026-0818	Open Eye Snap Bolt	Nickel	0.395in	4in	N/A	N/A	Snap	Latch	Crimp	Tuff-Tow	10Pk
SPRING187NE	Snap Hook With Latch	Zinc	3/16in	1.934in	.28in	N/A	Snap	Latch	Pearl	Tuff-Tow	Each
SPRING250NE	Snap Hook With Latch	Zinc	1/4in	2.35in	.34in	N/A	Snap	Latch	Pearl	Tuff-Tow	Each

Cargo Control

S-Hook



Crimp Style



Crimp Style With Latch

A:Chain Size **B:**Length **C:**Opening **D:**Working Load(GTWR) **E:**Type **F:**Safety Latch **G:**Mount Type **H:**MFG

Item Number	Description	Color	A	B	C	D	E	F	G	H	Extra Info
CU81260	S-Hook No Latch	Zinc	3/8in	N/A	N/A	2000lbs	S-Hook	N/A	Crimp	Curt	Bulk
CU81270	S-Hook No Latch	Zinc	7/16in	N/A	N/A	5000lbs	S-Hook	No Latch	Crimp	Curt	Each
CU81620	S-Hook No Latch	Zinc	17/32in	N/A	N/A	7600lbs	S-Hook	N/A	Crimp	Curt	Bulk
CU81640	S-Hook No Latch	Zinc	13/32in	N/A	N/A	3500lbs	S-Hook	N/A	Crimp	Curt	Bulk
CU81810	S-Hook With Wire Latch	Zinc	3/8in	N/A	N/A	2000lbs	S-Hook	Wire	Crimp	Curt	Bulk
CU81820	S-Hook With Wire Latch	Zinc	7/16in	N/A	N/A	5000lbs	S-Hook	Wire	Crimp	Curt	Bulk
CU81830	S-Hook With Wire Latch	Zinc	17/32in	N/A	N/A	7600lbs	S-Hook	Wire	Crimp	Curt	Bulk
CU81840	S-Hook With Wire Latch	Zinc	13/32in	N/A	N/A	3500lbs	S-Hook	Wire	Crimp	Curt	Each
TSL1	Pear Hook With Latch	Zinc	3/8in	N/A	N/A	750lbs	S-Hook	Latch	Crimp	Tuff-Tow	Each
TSL2	S-Hook With Wire Latch	Zinc	7/16in	N/A	N/A	1250lbs	S-Hook	Latch	Crimp	Tuff-Tow	Each
TSL4	S-Hook With Wire Latch	Zinc	17/32in	N/A	N/A	1900lbs	S-Hook	Latch	Crimp	Tuff-Tow	Each

Cargo Control

Latches



A: Length **B:** Width **C:** MFG

Item Number	Description	Color	SO	A	B	C
3602	Blind Mount T Handle	Chrome	Yes	4in	2.75in	Tuff-Tow
B215806	Cam Lock Asy Handle	Cast		----	N/A	Buyers
B2585B	Straight Stake Rack Connector Set	Raw		7in	2.5in	Buyers
B2585BZ	Straight Stake Rack Connector Set	Zinc Plated	Yes	7in	2.5in	Buyers
B2588BZ	Side Rail Latches	Zinc		N/A	N/A	Tuff-Tow
B2589BZ	Latch Corner Side Rails	Zinc		N/A	N/A	Tuff-Tow
B2591B	Corner Stake Rack Connector Set	Raw		3.625in	2.5in	Buyers
B2591BZ	Corner Stake Rack Connector Set	Zinc		3.625in	2.5in	Buyers
B2595	Spring Latch 1/2in	Zinc Plated		5.19in	1.75in	Buyers
B2595LKB	Spring Latch Asy w/Keeper 1/2in	Zinc Plated		5.19in	1.75in	Buyers
B2596	Heavy Duty Spring Latch 3/4in	Zinc Plated		5.91in	2.09in	Buyers
B575CZ	Nut Lever 1/2-13in Thread	Zinc Plated		4in	7/16in	Buyers
BDP100	Telescoping Door & Lid Drop	Zinc Plated	Yes	21inExt	13.125in Ret	Buyers
BHC801Z	Pull Down Catch HD	Zinc Plated	Yes	N/A	N/A	Buyers
BSP	Striker Plate	Plain	Yes	N/A	N/A	Buyers
TTH14D	Door Hinge Inside Bend	Zinc Plated		14in	1.95in	Tuff-Tow
TTH16	Door Hinge Inside Str	Zinc Plated		16in	1.95in	Tuff-Tow
TTH16D	Door Hinge Inside Bend	Zinc Plated		16in	1.95in	Tuff-Tow
WJ195	Hood Catch w/Bracket	Zinc Plated		4in	N/A	Buyers
WJ201A	Hood Catch w/Bracket	Zinc Plated		4-7/8in	N/A	Buyers
WJ201SS	Rubber Hood Catch w/Stainless Steel Hardware		Yes	4.875in	----	Buyers
WJ202	Mini Rubber Hood Catch w/Bracket	Black		2-1/2in	N/A	Buyers
WJ205	Hood Catch HD w/Brackets	Zinc Plated		6in	N/A	Buyers
WJ208RO	Hood Catch Replacement Rubber	Black	Yes	7-7/8in	N/A	Buyers
WJ211	Hood Catch Polymer	Black		12in	N/A	Buyers
WJ96WCB	Hood Catch 90 Deg Elbow	Black		N/A	N/A	Buyers

Cargo Control

Latches (Continued)

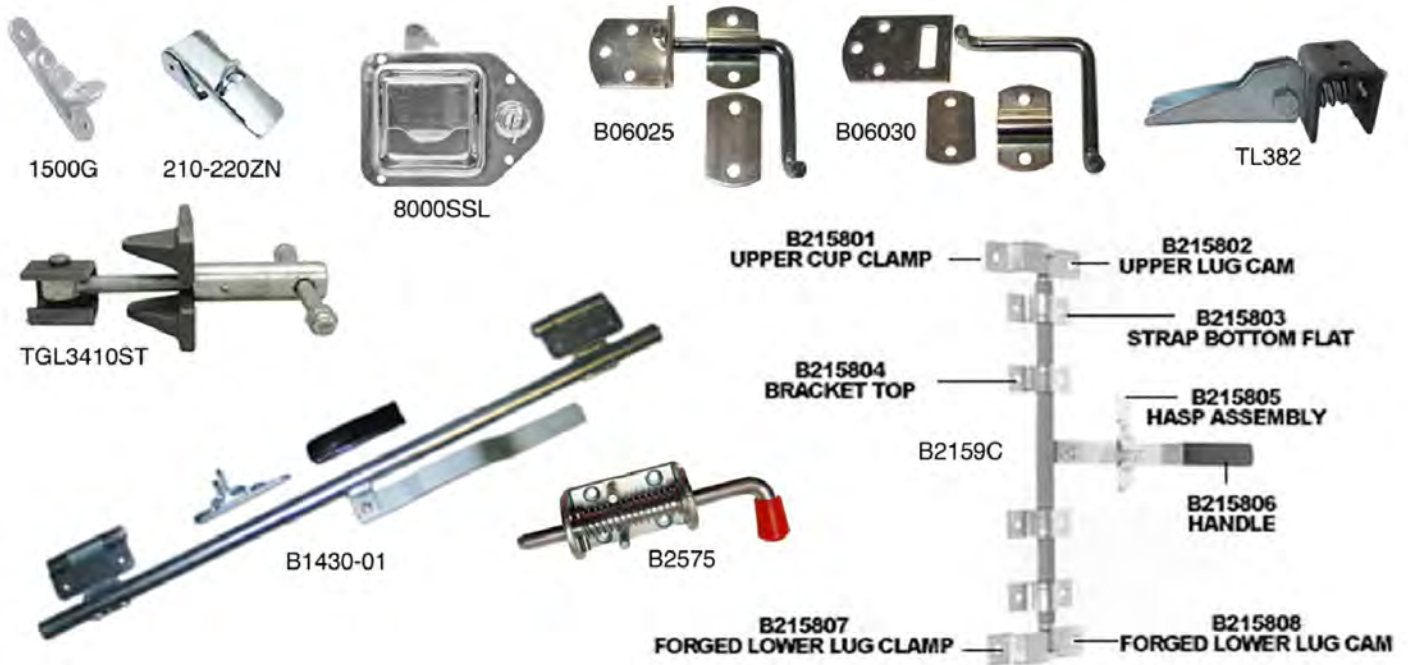

A: Length **B:** Width **C:** MFG

Item Number	Description	Color	SO	A	B	C
1500G	Lock Cam Hasp	Zinc		4-1/4in	----	Tuff-Tow
210-220ZN	Latches w/Padlocking Hasp	Zinc	Yes	3.17in	1.13in	Tuff-Tow
3002981	Replacement Latch Kit	----	Yes	----	----	Buyers
315LSS	Cab Latch Left	Stainless	Yes	3.39in	2in	Tuff-Tow
315LSS-01	Cab Latch Left	Stainless	Yes	3.39in	2in	Tuff-Tow
315RSS-01	Cab Latch Right	Stainless	Yes	3.39in	2in	Tuff-Tow
8000SSL	Mini Teardrop Locking Latch	Stainless		4.36in	3.27in	Buyers
B06025	Straight Side Latch Set	Zinc Plated		N/A	N/A	Buyers
B06030	Corner Security Latch Set	Zinc Plated		N/A	N/A	Buyers
B1430-01	Bar Lock Assembly	Zinc Plated		36in	18in	Tuff-Tow
B2159C	Cam Action Latch Kit No Pipe	Cast Steel		N/A	N/A	Buyers
B2575	Snap Pin Lock	Zinc		1.250in	----	Buyers
L3885RLS	Rotary Paddle Latch	Stainless	Yes	5.5in	4.25in	Buyers
L3890RLS	Rotary Paddle Latch	Stainless	Yes	5.5in	4.25in	Buyers
L8835	Triple Point T Handle Latch	Stainless	Yes	5.5in	4.25in	Buyers
LC202290	Travel Trailer Latch	Black	Yes	----	----	Lippert
LC204309	Travel Trailer Latch	White	Yes	----	----	Lippert
LC204310	Travel Trailer Latch	Chrome	Yes	----	----	Lippert
TGL3410ST	Tail Gate Latch Assembly	Steel		----	----	Buyers
TL382	Tipper Latch Assembly	Zinc Plated		5.98in	2in	Buyers
TTL36	Bar Lock Assembly	Zinc Plated		36in	N/A	Tuff Tow
TTL45	Bar Lock Assembly	Zinc Plated		45in	N/A	Tuff-Tow
TTL55	Lock Bar Assembly			55in	----	Tuff-Tow

Cargo Control

Door Holder



600



620
620-01
620-03
620-07

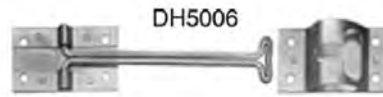

DH5006

A: Length **B:** Width **C:** MFG

Item Number	Description	Color	SO	A	B	C
600	Female Door Socket	White		1.34in	.90in	Tuff-Tow
620	2-Pc Door Holder	Aluminum		2in	3.28in	Buyers
620-01	2-Pc Door Holder	Aluminum		4in	3.28in	Buyers
620-03	Door Hold Back	Aluminum	Yes	6in	3.28in	Tuff-Tow
620-07	Door Hold Back	Aluminum	Yes	10in	3.28in	Tuff-Tow
DH5006	T-Style Door Holder	Zinc Plated		6in	N/A	Buyers

Hinge



B2423G



B2426FS
B2426FSL



B2426SSCL
B2426ZL
B2426ZR



H412550LH
H412550RH



FBP150GF
FSP100
FSP150



FBP100GF



S41
S42
S43
S72
SS21

A: Length **B:** Width **C:** MFG

Item Number	Description	Color	SO	A	B	C
B2423G	Strap Hinge Leaf	Zinc	Yes	15.19in	5in	Buyers
B2426FS	Short Strap Hinge w/Zirk	Raw		3.85in	4.33in	Buyers
B2426FSL	Long Strap Hinge w/Zirk	Zinc		5.85in	4.33in	Buyers
B2426SSCL	Left Flush Hinge	Cast Steel	Yes	5.59in	3.28in	Buyers
B2426SSCR	Right Flush Hinge	Cast Steel	Yes	5.59in	3.28in	Buyers
B2426ZL	Left Flush Hinge	Zinc Alloy	Yes	5.59in	3.28in	Buyers
B2426ZR	Right Flush Hinge	Zinc Alloy	Yes	5.59in	3.28in	Buyers
FBP100GF	Weld-On Bullet Hinge	Steel/Brass		4in	16mm	Buyers
FBP150GF	Weld-On Bullet Hinge	Steel/Brass		6in	20mm	Buyers
FSP100	Weld-On Bullet Hinge	Steel/Brass		4in	16mm	Buyers
FSP150	Weld-On Bullet Hinge	Steel/Brass		6in	20mm	Buyers
H412550LH	Left Butt Hinge	Zinc		4in	1-1/4in W	Buyers
H412550RH	Right Butt Hinge	Zinc		4in	1-1/4in W	Buyers
S41	Continuous Hinge 14ga	Steel	Yes	72in	1.5in	Buyers
S42	Continuous Hinge 14ga	Steel	Yes	72in	2in	Buyers
S43	Continuous Steel Hinge 14ga	Plain	Yes	72in	2.5in	Buyers
S72	Continuous Steel Hinge 7ga	Plain	Yes	72in	3in	Buyers
SS21	Continuous Hinge 11ga	Stainless	Yes	72in	4in	Buyers

Cargo Control

D-Rings

Light-Duty Surface D-Ring

A: Diameter **B:** Height & Width **C:** Capacity **D:** Ring Dia. **E:** Mfg.



Item Number	Description	Color	A	B	C	D	E	Extra Info
B20	Rope D-Ring	Steel	1/4in	1x1.3125	.8K	N/A	Buyers	Bulk
B21	D-Ring w/Clip	Black	1/4in	2x1.5in	.8K	N/A	Buyers	Bulk
B23	D-Ring LD w/Surface Mount	Zinc	1/4in	1.5x1.25in	.4K	N/A	Buyers	Bulk
CU83730	Rope D-Ring	Zinc	.225in	1.8125x1.5in	1.2K	1x1.3125in	Curt	Bulk
CU83731	Rope D-Ring	Zinc	.225in	1.8125x1.5in	1.2K	1x1.3125in	Curt	2Pk
CU83732	Rope D-Ring	Stainless	.225in	1.8125x1.5in	1.2K	1x1.3125in	Curt	Bulk

Heavy Duty Bolt-On D-Ring

A: Diameter **B:** Height & Width **C:** Capacity **D:** Ring Dia. **E:** Mfg.



Item Number	Description	Color	A	B	C	D	E	Extra Info
B38	D-Ring w/Bolt-On Bracket	Raw	1/2in	2.5x2.375in	4.08K	N/A	Buyers	Bulk
CU83740	Forged D-Ring w/Mount Brkt	Yellow Zinc	1/2in	2.5x2.375in	11K	1.625x.1875in	Curt	Bulk
CU83742	Forged D-Ring w/Mount Brkt	Zinc	1/2in	2.5x2.375in	11K	1.625x.1875in	Curt	Bulk
TT38	Bolted D-Ring	Raw	1/2in	2.5x2.375in	4.08K	N/A	Tuff-Tow	Bulk

Heavy Duty Weld-On D-Ring

A: Diameter **B:** Height & Width **C:** Capacity **D:** Ring Dia. **E:** Mfg.



Item Number	Description	Color	A	B	C	D	E	Extra Info
B28	Weld-On D-Ring	Zinc	3/8in	1.5x1.25in	2K	N/A	Buyers	Bulk
B38BF	Weld-On D-Ring Bracket	Raw	1/2in	N/A	N/A	N/A	Buyers	Bulk
B38R	D-Ring Only	Raw	1/2in	2.5x2.375in	4.08K	N/A	Buyers	Bulk
B38W	Weld-On D-Ring Bracket	Raw	1/2in	2.5x2.375in	4.08K	N/A	Buyers	Bulk
B40	Weld-On D-Ring Bracket	Raw	5/8in	3x3in	6.13K	N/A	Buyers	Bulk
B40BF	Forged Ring Bracket	Raw	5/8in	N/A	N/A	N/A	Buyers	Bulk
B40R	D-Ring Only	Raw	5/8in	3x3in	6.13K	N/A	Buyers	Bulk
B46	Weld-On D-Ring Bracket	Raw	3/4in	3x3in	9.12K	N/A	Buyers	Bulk
B46BF	Forged D-Ring Bracket	Black	3/4in	3x3in	9.12K	N/A	Buyers	Bulk
B46R	D-Ring Only	Raw	3/4in	3x3in	9.12K	N/A	Buyers	Bulk
B48	Weld-On D-Ring Bracket	Raw	1in	3x3in	15.586K	N/A	Buyers	Bulk
B48R	D-Ring Only	Raw	1in	3x3in	15.586K	N/A	Buyers	Bulk
B50	Weld-On D-Ring Bracket	Raw	1in	4x3in	15.586K	N/A	Buyers	Bulk
B50BF	Forged D-Ring Bracket	Raw	1in	4x3in	15.586K	N/A	Buyers	Bulk
B50R	D-Ring Only	Raw	1in	4x3in	15.586K	N/A	Buyers	Bulk
CU83750	Lashing D-Ring w/Bracket	Raw	5/8in	3x3in	18k	1.875x.375in	Curt	Poly
CU83760	Lashing D-Ring w/Bracket	Raw	3/4in	3x3in	26.5k	1.875x.375in	Curt	Poly
CU83770	Lashing D-Ring w/Bracket	Raw	1in	3x3in	46.760k	2x.375in	Curt	Poly
CU83780	Lashing D-Ring w/Bracket	Raw	1in	4x3in	46.760k	2x.375in	Curt	Poly
TT38W	Weld-On D-Ring	Raw	1/2in	2.5x2.375in	4.08K	N/A	Tuff-Tow	Bulk
TT40W	Welded D-Ring	Raw	5/8in	3x3in	6.13K	N/A	Tuff-Tow	Bulk
TTB46	Weld-On D-Ring w/Bracket	Raw	3/4in	3x3in	9.12K	N/A	Tuff-Tow	Bulk
TTB48	Weld-On D-Ring w/Bracket	Raw	1in	3x3in	15.5K	N/A	Tuff-Tow	Bulk
TTB50	Weld-On D-Ring w/Bracket	Raw	1in	4x3in	15.5K	N/A	Tuff-Tow	Bulk

Cargo Control

D-Rings Recessed D-Ring



02020
B601
CU83601



02030
B801
CU83600
CU83650



B38PN



B38RP



B701 & CU83710



B901D



B99



CU83607



CU83720



B801BP



B801AK

A: Diameter **B:** Height & Width **C:** Capacity **D:** Ring Dia. **E:** Mfg.

Item Number	Description	Color	A	B	C	D	E	Extra Info
02020	Recessed Rope D-Ring	Zinc	1/4in	1.89x1.218in	.285K	5x3.5in	Buyers	4Pk
02030	Recessed Rope D-Ring	Zinc	13/32in	1.405in	2K	4.5x4.25in	Buyers	1Pk
B38PN	Recessed Rectangular Pan Fits B38	Zinc	N/A	3-3/4x5in	N/A	N/A	Buyers	Bulk
B38RP	D-Ring w/ Mount Bracket & Recessed Pan	Raw	1/2in	2.5x2.375in	4.08K	N/A	Buyers	Bulk
B601	Recessed Rope D-Ring	Zinc	1/4in	1.89x1.218in	.285K	5x3.5in	Tuff-Tow	Bulk
B701	Recessed Rope D-Ring	Zinc	1/4in	1.4375x1in	.265K	3.5in	Buyers	Bulk
B801	Recessed 4-Bolt D-Ring	Zinc	13/32in	3x3.25in	6K	4.5x4.25in	Buyers	Bulk
B801AK	Rope D-Ring w/ Back Plate Kit	Zinc	13/32in	3x3.25in	6K	4.5x4.25in	Buyers	Pk
B801BP	Back Plate For B801	Galvanized	N/A	3.5in	N/A	6.5x6.5in	Buyers	Bulk
B901BP	Back Plate For 901D	Zinc Plated	N/A	4.63in	N/A	6.5x6.5in	Buyers	Bulk
B901D	Recessed Rotating Rope D-Ring	Zinc	9/16in	2.75x1.1875in	2K	6.38in	Buyers	Pk
B99	Recessed Rope w/ Plastic Bezel	Zinc	1/4in	1.75x1.234in	.265K	3.52in	Buyers	Bulk
CU83600	Recessed Tie Down	Zinc	13/32in	3x3.25in	5K	4.5x4.25in	Curt	Bulk
CU83601	Recessed Rope D-Ring	Zinc	1/4in	1.89x1.218in	1.2K	5x3.5in	Curt	Bulk
CU83607	Backing Plate	Steel	N/A	N/A	N/A	N/A	Curt	Bulk
CU83650	Recessed Tie Down	Yellow Zinc	3/16in	3x3.25in	7.5K	4.5x4.25in	Curt	Bulk
CU83710	Recessed D-Ring	Zinc	1/4in	1.4375x1.54in	1K	3.5in	Curt	Bulk
CU83720	Plastic Trim for CU83710	Black	.36in	N/A	N/A	4.06in	Curt	Bulk

Surface Mounted D-Ring



B501



B705

A: Diameter **B:** Height & Width **C:** Capacity **D:** Ring Dia. **E:** Mfg.

Item Number	Description	Color	A	B	C	D	E	Extra Info
B501	Surface Mount D-Ring	Zinc	1/4in	1.562x1.125in	.5K	5.164x3.75in	Buyers	Bulk
B705	Surface Mount Rope D-Ring	Zinc	1/4in	1.91x1.41in	1K	3.91in	Buyers	Bulk

Cargo Control

E-Track



49363-10-72



ST93



LR1



B01077



B01080



SPPGF



B01090



2019-060



HET



HET1845



HET8066-3

A: Width **B:** Length **C:** Height **D:** Capacity **E:** Mfg.

Item Number	Description	SO	A	B	C	D	E
01120	E-Track J Hook 4.25 ID	Yes	N/A	N/A	N/A	N/A	Buyers
01130	E-Track J Hook 2.00 ID	Yes	N/A	N/A	N/A	N/A	Buyers
2019-060	E-Track Vertical		3.47in	5ft	0.42in	50K psi	Kinedyne
43002R	E-Track Horizontal	Yes	5in	10ft	N/A	50K psi	Kinedyne
43009-2	E-Track Wood Beam Socket	Yes	----	----	----	Varies	Kinedyne
47556-11	Spring Loaded Tie Down Ring		N/A	N/A	N/A	1666lbs	Tuff-Tow
49363-10-72	Floor Track Low Profile		2.6in	72in	0.5in	Varies	Phoenix
B01077	E-Track Tie Down		2in	20ft	N/A	1000lbs	Kinedyne
B01080	E-Track Tie Down		2in	6in	N/A	1000lbs	Tuff-Tow
B01090	E-Track Rope Ring Fitting		N/A	N/A	N/A	2000lbs	Tuff-Tow
HET	E-Track Horizontal		5in	10ft	0.42in	Varies	Kinedyne
HET1845	E-Track Wood Beam Socket		2in	4in	3.5in	Varies	Buyers
HET8066-3	E-Track Aluminum Beam		N/A	91.9-102in	N/A	2000lbs	Kinedyne
HET8730	E-Track End Cap		.73in	5.17in	.44in	N/A	Kinedyne
LR1	Track Load Ring		N/A	N/A	N/A	400lbs	Buyers
RA-16H	E-Track Spare Tire Hook	Yes	N/A	N/A	N/A	N/A	Tuff-Tow
SPPGF	Floor Track End Cap		N/A	N/A	N/A	N/A	Phoenix
ST93	Aluminum Wall Track Set		1.125in	46.5in	.41in	420lbs	Buyers

Cargo Control

Pins Clevis Pins



43073
43074
43077
43079



43082 66100
43083 66120
43084 66125
43085
43086



P47630

A: Diameter **B:** Usable Length **C:** Overall Length **D:** Mfg.

Item Number	Description	SO	A	B	C	D
00182	Pin Hair	Yes	----	----	----	Demco
01718-95	Locking Pin	Yes	----	----	----	Demco
02397	Standard Lynch Pin	Yes	1/4in	1.688in	----	Demco
43073	Receiver Pin w/Flip Lever Zinc		1/2in	3 1/2in	4-3/4in	Tuff-Tow
43074	Receiver Pin w/Flip Lever Zinc		5/8in	3 1/2in	4-3/4in	Tuff-Tow
43077	Receiver Pin w/Flip Lever Zinc		1in	3 1/2in	4-3/4in	Tuff-Tow
43079	Hitch Pin	Yes	7/8in	6in	----	Tuff-Tow
43082	Clevis Pin w/Clip		5/8in	4-1/2in	6in	Tuff-Tow
43083	Clevis Pin w/Clip		3/4in	4-1/4in	5-3/4in	Buyers
43084	Clevis Pin w/Clip		1in	4in	6in	Buyers
43085	Clevis Pin w/Clip		5/8in	6-1/4in	7-5/8in	Buyers
43086	Clevis Pin w/Clip		3/4in	6-1/4in	7-5/8in	Buyers
66100	Clevis Pin w/Clip		1/2in	4-1/4in	5-3/4in	Buyers
66120	Clevis Pin w/Clip		7/8in	6-1/4in	7-3/4in	Buyers
66125	Clevis Pin w/Clip		1in	6-1/4in	7-3/4in	Buyers
P47630	Hitch Pin Steel Plated		5/8in	6in	----	Tuff-Tow

Lynch Pins

A: Dia. **B:** Usable Length **C:** Overall Length **D:** Mfg.

Item Number	Description	A	B	C	D
BX84-0001	Snap Lynch Pin	1/4in	1-3/4in	2-1/4in	Blue Ox
LP3072	Lynch Pin	7/16in	1-1/2in	1-3/4in	Buyers
LP4072	Lynch Pin	1/4in	1-5/16in	1-3/4in	Buyers
LP7203	Lynch Pin	7/16in	1-5/8in	1-5/16in	Tuff-Tow
LP8453	Lynch Pin	3/16in	1-7/16in	1-9/16in	Buyers
LP9072	Lynch Pin	5/16in	1-1/2in	1-3/4in	Tuff-Tow



Cargo Control

Pins Loxall & Snapper Pins



A: Diameter **B:** Usable Length **C:** Overall Length **D:** Mfg.

Item Number	Description	A	B	C	D
66050	Ring Pin	1/4in	1-3/4in	2-1/4in	Buyers
66060	Ring Pin	3/8in	2-1/4in	2-3/4in	Buyers
66063	Snapper Pin	1/4in	2-3/4in	2-49/64in	Buyers
66070	Snapper Pin	1/4in	3-1/2in	3-3/4in	Buyers
B66066	Snapper Pin	1/4in	3in	3-1/4in	Buyers
BX142	Loop Pin Lock	1/4in	1-3/4in	2-1/4in	Tuff-Tow
LX122	Loxall Pin	1/2in	1-5/8in	2-5/8in	Tuff-Tow
LX123	Loxall Pin	1/2in	2-1/2in	3-1/2in	Tuff-Tow
LX124	Loxall Pin	1/2in	3-1/2in	4-5/8in	Tuff-Tow
LX126	Loxall Pin	1/2in	4-1/2in	5-5/8in	Tuff-Tow
LX142	Loxall Pin	1/4in	1-1/4in	2-1/2in	Tuff-Tow
LX143	Loxall Pin	1/4in	2-1/8in	2-7/8in	Tuff-Tow
LX144	Loxall Pin	1/4in	3in	3-3/4in	Tuff-Tow
LX344	Loxall Pin	3/4in	3-1/2in	4-3/4in	Tuff-Tow
LX348	Loxall Pin	3/4in	6-1/4in	7-3/8in	Tuff-Tow
LX382	Loxall Pin	3/8in	1-1/2in	2-3/8in	Tuff-Tow
LX383	Loxall Pin	3/8in	2-3/8in	3-1/4in	Tuff-Tow
LX384	Loxall Pin	3/8in	3in	4in	Tuff-Tow
LX385	Loxall Pin	3/8in	4-1/8in	5in	Tuff-Tow
LX5162	Loxall Pin	5/16in	2-1/4in	3-1/8in	Tuff-Tow
LX5163	Loxall Pin	5/16in	2-1/2in	3-3/8in	Tuff-Tow
LX5164	Loxall Pin	5-16in	3-5/8in	4-1/2in	Tuff-Tow
LX584	Loxall Pin	5/8in	3-1/2in	4-1/2in	Tuff-Tow
LX586	Loxall Pin	5/8in	4-1/8in	5-1/4in	Tuff-Tow
LX588	Loxall Pin	5/8in	6-1/8in	7-1/4in	Tuff-Tow
LX9163	Loxall Pin	9/16in	3in	4-1/8in	Tuff-Tow

Cargo Control

Stakes, Pockets & Slats Pockets Bayer



A: Top Width ID **B:** Top Depth ID **C:** BTM Width ID **D:** BTM Depth ID **E:** Length **F:** Mfg.

Item Number	Description	A	B	C	D	E	F	Extra Info
410	Pocket For Bayer Style Stake	3in	1.875in	2.5in	1.75in	5in	Tuff-Tow	----
411	Bayer Style Sleeve (fits 410)	N/A	N/A	N/A	N/A	N/A	Tuff-Tow	Use With 2x4
475	Pocket For Bayer Style Stake	3in	1.875in	2.5in	1.75in	5in	Tuff-Tow	----

Stakes Bayer

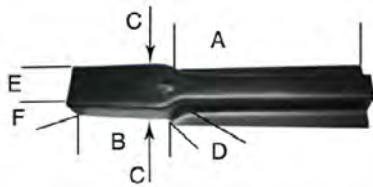

Only fits 410 pocket

A: Length Above Pocket **B:** Pocket Length **C:** Top Width OD **D:** Top Depth OD
E: BTM Width OD **F:** BTM Depth OD **G:** Mfg.

Item Number	Description	A	B	C	D	E	F	G
4011	Bayer Style Stake	11in	5in	2.71in	1.72in	2.42in	1.65in	Tuff-Tow
4012	Bayer Style Stake	12in	5in	2.71in	1.72in	2.42in	1.65in	Tuff-Tow
4012-Z	Bayer Style Stake	12in	5in	2.71in	1.72in	2.42in	1.65in	Tuff-Tow
4018	Bayer Style Stake	18in	5in	2.71in	1.72in	2.42in	1.65in	Tuff-Tow
4024	Bayer Style Stake	24in	5in	2.71in	1.72in	2.42in	1.65in	Tuff-Tow
4036	Bayer Style Stake	36in	5in	2.71in	1.72in	2.42in	1.65in	Tuff-Tow
4042	Bayer Style Stake	42in	5in	2.71in	1.72in	2.42in	1.65in	Tuff-Tow
4048	Bayer Style Stake	48in	5in	2.71in	1.72in	2.42in	1.65in	Tuff-Tow
4060	Bayer Style Stake	60in	5in	2.71in	1.72in	2.42in	1.65in	Tuff-Tow
4072	Bayer Style Stake	72in	5in	2.71in	1.72in	2.42in	1.65in	Tuff-Tow

Pockets Buyers

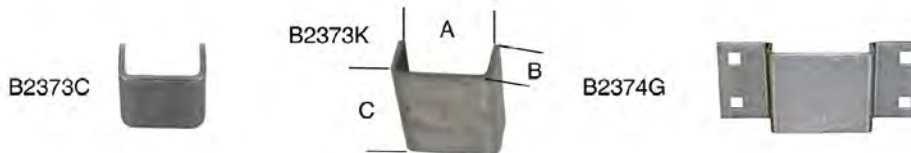

A: ID Width **B:** ID Depth **C:** Length **D:** Mfg.

Item Number	Description	A	B	C	D	Extra Info
B2373C	Stake Pocket	3.5in	1.75in	4in	Buyers	Weld-On for 2x4
B2373K	Stake Pocket Straight	3in	1.5in	4in	Buyers	Weld-On
B2374G	Stake Pocket	3in	1.5in	2.5in	Buyers	Bolt-On for 2x4
CU83072	Pocket Anchor	3.5in	1.625in	4in	Curt	Weld-on-Raw

Cargo Control

Stakes, Pockets & Slats Stakes Buyers

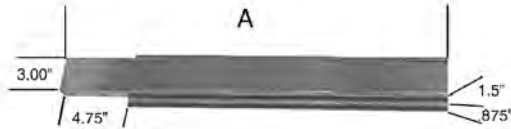

Use With B2373K Only

A: Length

Item Number	Description	A	B	Extra Info
BSA1447WDNH	Stake	47in	Buyers	Works w/B2373K Only

Pockets Flemming



A: Top Width ID B: Top Depth ID C: BTM Width ID D: BTM Depth ID E: Length F: Mfg.

Item Number	Description	Color	SO	A	B	C	D	E	F	Extra Info
421-B	Flemming Style Sleeve (fits 483X)	Black		3in	1.7in	2.6in	1.3in	7in	Tuff-Tow	Use with 2x4
421Z	Flemming Sleeve	Zinc	Yes	3in	1.7in	2.6in	1.3in	7in	Tuff-Tow	----
483	Flemming Style Pocket	Black		3.125in	1.72in	2.65in	1.5in	5in	Tuff-Tow	12ga Weld-on w/Bk Plate
483X	Flemming Style Pocket	Black		3.125in	1.72in	2.65in	1.5in	5in	Tuff-Tow	12 Ga.

Stakes Flemming

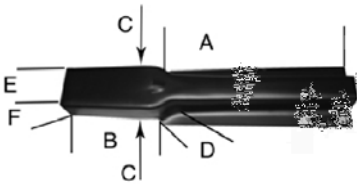

Use with 483X

A: Length Above Pocket B: Pocket Length C: Top Width OD D: Top Depth OD E: BTM Width OD F: BTM Depth OD G: Mfg.

Item Number	Description	Color	A	B	C	D	E	F	G
4212	Flemming Style Stake	Black	12in	5in	2.82in	1.70in	2.63in	1.45in	Tuff-Tow
4218	Flemming Style Stake	Black	18in	5in	2.98in	1.64in	2.64in	1.29in	Tuff-Tow
4224	Flemming Style Stake	Black	24in	5in	2.82in	1.70in	2.63in	1.45in	Tuff-Tow
4236	Flemming Style Stake	Black	36in	5in	2.98in	1.64in	2.64in	1.29in	Tuff-Tow
4242	Flemming Style Stake	Black	42in	5in	2.98in	1.64in	2.64in	1.29in	Tuff-Tow
4248	Flemming Style Stake	Black	48in	5in	2.82in	1.70in	2.63in	1.45in	Tuff-Tow
4248Z	Flemming Style Stake	Zinc	48in	5in	2.82in	1.70in	2.63in	1.45in	Tuff-Tow
4254	Flemming Style Stake	Black	54in	5in	2.98in	1.64in	2.64in	1.29in	Tuff-Tow
4260	Flemming Style Stake	Black	60in	5in	2.98in	1.64in	2.64in	1.29in	Tuff-Tow

Cargo Control

Roof Vents

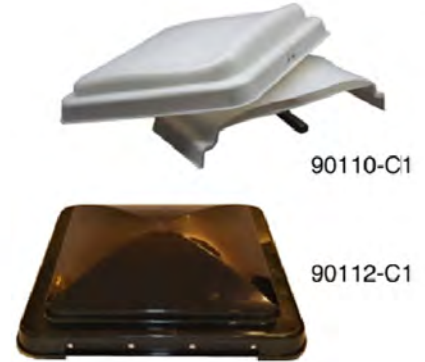
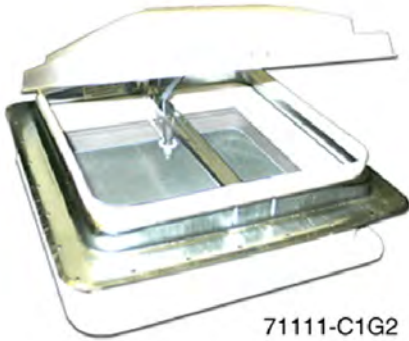

A: Size B: Mfg.

Item Number	Description	Color	A	B
71111-C	Metal Frame Roof Vent	White	14x14in	Tuff-Tow
71111-C1G2	Metal Frame Roof Vent	White	14x14in	Tuff-Tow
90091	Roof Garnish	White	1-3/4x2-3/4in	Tuff-Tow
90110-C1	Universal Vent Lid	White	14inx14in	Tuff-Tow
90112-C1	Universal Vent Lid	Smoke	14inx14in	Tuff-Tow

Cargo Control

Tie Down Boat Rollers & Accessories Boat Roller



A: Diameter B: Length C: Bolt Hole D: Mfg.

Item Number	Description	SO	A	B	C	D
312B	Bent Channel Roller		2-1/8in	12in	1/4in	Tuff-Tow
PR12	Boat Roller		3-1/4in	11-1/2in	5/8in	Tuff-Tow
PR212	Boat Roller		2-13/32in	11-1/2in	9/16in	Tuff-Tow
PR44	Boat Roller	Yes	3-5/8in	3-3/8in	3/4in	Tuff-Tow
PR4-5	Boat Roller		2-11/16in	3-5/8in	1/2in	Tuff-Tow
PR4B	Boat Roller	Yes	2-29/64in	3-3/4in	1/2in	Tuff-Tow
PR5	Boat Roller		2-25/32in	4-1/2in	5/8in	Tuff-Tow
TD46437B	Wobble Roller		4in	4in	3/4in	Tie Down
TD48374B	Keel Roller		2-25/32in	4in	5/8in	Tie Down
TD48389	Keel Roller		3-1/2in	8in	5/8in	Tie Down
TD48719B	Wobble Ribbed Roller		5in	3in	1-1/2in	Tie Down
TD48721B	Bowtie Roller		3-1/2in	4-3/4in	5/8in	Tie Down
TD48722B	Spooler Roller		5/8in	5in	----	Tie Down
TD86142	Bow Roller Assesmbly		1/2in	4in	N/A	Tie Down
TD86159	Keel Roller	Yes	3-1/2in	8in	5/8in	Tie Down
TD86400	Bow Roller		3in	4in	1/2in	Tie Down
TD86405	Bow Roller Asy		4-1/2in	5-1/2in	1/2in	Tie Down
TD86407	Center Keel Roller		3-1/2in	5in	5/8in	Tie Down
TD86410	Keel Roller		3-1/2in	10in	5/8in	Tie Down
TD86411	Keel Roller		3-1/2in	12in	5/8in	Tie Down
TD86414	Keel Roller w/5-3/8in Panel Bracket	Yes	3in	5in	5/8in	Tie Down
TD86417	Keel Roller w/12-3/8in Panel Bracket		3-1/2in	12in	5/8in	Tie Down
TD86428	Wobble Roller		4-1/8in	4in	3/4in	Tie Down
TD86435	Hull Sav'r Display Kit	Yes	N/A	N/A	N/A	Tie Down

Cargo Control

Tie Down Boat Rollers & Accessories Bow Stop



BB1 & BB2



PA2



PA3



PA4



PA5



PA6



PR3V



PR4V



TD86413



TD86420



TD86421

A: Diameter B: Length C: Bolt Hole D: Opening E: Mfg.

Item Number	Description	SO	A	B	C	D	E
BB1	Bolt-Through Bumper 3/8in		3/8in	3in to 4-1/2in	1/2in	3/4in	Kodiak
BB2	Bolt-Through Bumper 1/2in		1/2in	3in to 4-1/2in	1/2in	1in	Kodiak
PA3	Jet Ski Bow Stop 3-5/8in		9/16in	3-59/64in	N/A	2-1/2in	Tuff-Tow
PA4	Jet Ski Bow Stop 4-5/8in	Yes	9/16in	5-1/2in	N/A	2-1/2in	Tuff-Tow
PA5	Bow Stop 5in		5/8in	5-1/8in	N/A	3-3/4in	Tuff-Tow
PA6	Bow Stop 5/8in		5/8in	6-3/4in	N/A	3-3/4in	Tuff-Tow
PR3V	Bow Stop 3in		1/2in	4-1/4in	N/A	2-13/16in	Tuff-Tow
PR4V	Bow Stop 4in		1/2in	6in	N/A	3-11/16in	Tuff-Tow
SBS3	Supreme Bow Stop 3in		1/2in	6-5/8in	5-1/4in	N/A	Tuff-Tow
SBS4	Supreme Bow Stop 4in		1/2in	7-5/8in	5-1/4in	N/A	Tuff-Tow
TD86413	V Bow Stop 3in		N/A	3in	1/2in	N/A	Tie Down
TD86420	V Bow Stop 2in		N/A	2in	3/8in	N/A	Tie Down
TD86421	V Bow Stop 4in		N/A	4in	1/2in	N/A	Tie Down

Cargo Control

Tie Down Boat Rollers & Accessories Tie Down Roller & Brackets



TD81211



TD81215, TD81216, TD81221



TD86031



TD86115



TD86150



TD86310

A: Length B: Slot C: Bolt D: Nut E: Roller Size F: Width Between Slots G: Bracket Width

Item Number	Description	SO	A	B	C	D	E	F	G
TD43588A	Roller & Winch Combo Stand	Yes	33in	N/A	N/A	N/A	N/A	N/A	12inx5in
TD81211	Bolster Bracket w/Swivel		8in	1-1/16in	N/A	N/A	N/A	2-11/16in	2-1/2in
TD81215	Bolster Bracket w/Swivel	Yes	10in	1-1/16in	N/A	N/A	N/A	2-11/16in	2-1/2in
TD81216	Bolster Bracket w/Swivel		10in	1-1/16in	N/A	N/A	N/A	2-11/16in	2-1/2in
TD81221	Bolster Bracket w/Swivel		12in	1-1/16in	N/A	N/A	N/A	2-11/16in	2-1/2in
TD86029	Roller Shaft w/Pal Nuts		9-1/4in	N/A	5/8in	5/8in	N/A	N/A	N/A
TD86031	Roller Shaft w/Pal Nuts		13-1/4	N/A	5/8in	5/8in	N/A	N/A	N/A
TD86032	Roller Shaft w/Pal Nuts		15-1/4	N/A	5/8in	5/8in	N/A	N/A	N/A
TD86103	Post Guide-On Kit		48in	N/A	N/A	N/A	N/A	N/A	N/A
TD86115	Swivel Bracket		3-1/2in	N/A	1/2x1in	1/2in	N/A	N/A	2in
TD86125	Bunk Bracket		9-1/2in	6in	1/2in	N/A	N/A	N/A	2in
TD86140	Split Panel Brackets		6-1/8in	5in	N/A	N/A	Any	---	2in
TD86150	Panel Bracket		7in	5-17/32in	N/A	N/A	4in	2in	4-3/8in
TD86160	Swivel Brackets w/Nuts & Bolts		3-1/2in	N/A	1/2x1in	1/2in	N/A	N/A	N/A
TD86178	Roller Shaft		5-1/4in	N/A	5/8in	5/8in	N/A	N/A	N/A
TD86181	Roller Shaft		11-1/4in	N/A	5/8in	5/8in	N/A	N/A	N/A
TD86300	Pal Nuts		N/A	N/A	N/A	1/2in	N/A	N/A	N/A
TD86310	Pal Nuts-4pk		N/A	N/A	N/A	5/8in	N/A	N/A	N/A

Cargo Control

Tie Down Boat Rollers & Accessories Tie Down Boat Bunks & Guides

Cargo Control & Accessories

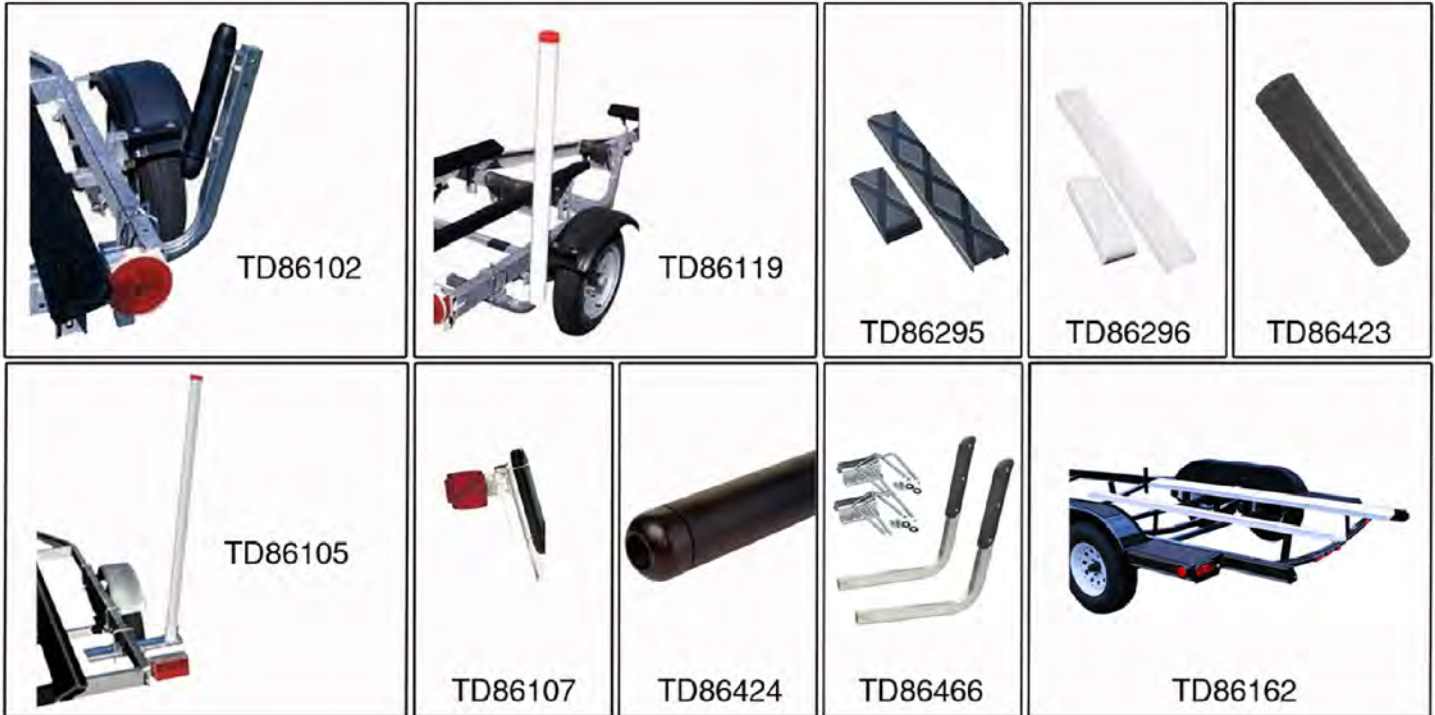

A: Size

Item Number	Description	Color	SO	A
TD86071	Tie Down Mate w/Handle	Chrome	Yes	N/A
TD86072	Tie Down Mate Anchor Kit	Chrome	Yes	N/A
TD86074	Tie Down Mate w/Handle	Chrome	Yes	N/A
TD86102	Fixed Angle Roller Guide	Galvanized	Yes	13in
TD86105	Boat Guide	Galvanized		4ftx2-3/8in
TD86107	Side Guide Light Bracket Kit	Galvanized		N/A
TD86119	Heavy Duty Guide On	Galvanized	Yes	60in
TD86162	Self Centering Bunk Glide On	White		2x4inx8ft
TD86295	Self Centering Bunk Glide On	Black	Yes	2x6inx8ft
TD86296	Self Centering Bunk Glide On	White	Yes	2x6inx8ft
TD86423	Roller Side Guide	Galvanized		12x12in
TD86424	End Cap for Side Guide	Black		2x1x1/2in
TD86466	Low Rider Guide On	Black	Yes	N/A
TD86475	Roller Side Guide	Galvanized		9x12in

Cargo Control

Tie Down Boat Rollers & Accessories Tie Down Bunk Boards & Carpet

A: Length

Item Number	Description	SO	A
TD86124	Bunk Board Guide On Kit	Yes	5ft
TD86127	Carpet Bunk Board-Pair		3ft
TD86129	Carpeted Bunk Boards-Pair	Yes	5ft
TD86137	Bunk Board Carpet-Roll		12ft
TD86138	Carpet Bunk		12ft
TD86164	Bunk Slicks	Yes	16in
TD86170	Bunk Slicks	Yes	17in



TD86129



TD86137

Cargo Control

Tie Down Boat Rollers & Accessories

Available by special order only.

Trailer Brackets

Panel Bracket Assemblies

Brackets are one piece, heavy duty hot dip galvanized 11 gauge steel, specifically designed to support keel rollers. Available with amber or black rollers. Assemblies include keel roller, shaft and pal nuts.

Part #	Color	Roller Size	Width Between Slots	Bracket Width
86279	Amber	5"	3"	5-3/8"
86414	Black	5"	3"	5-3/8"
86280	Amber	8"	6"	8-3/8"
86415	Black	8"	6"	8-3/8"
86281	Amber	10"	8"	10-3/8"
86416	Black	10"	8"	10-3/8"
86282	Amber	12"	10"	12-3/8"
86417	Black	12"	10"	12-3/8"



Panel Brackets

Brackets are one piece, heavy duty hot dip galvanized 11 gauge steel, specifically designed to support keel rollers. Slots accept 7/16" or 1/2" diameter bolts and provide vertical roller adjustment. Roller shaft diameter can be 1/2" or 5/8".

Part #	Roller Size	Width Between Slots	Bracket Width
86150	4"	2"	4-3/8"
86151	5"	3"	5-3/8"
86152	8"	6"	8-3/8"
86155	10"	8"	10-3/8"
86153	12"	10"	12-3/8"



Split Panel Brackets

Sold in pairs (right and left) to accommodate any size roller length. Slot allows vertical adjustment for stabilizing boat on trailer. Slots accept 7/16" or 1/2" bolts. Use 1/2" or 5/8" roller shaft.

2 per pack Part #81235
Bulk Part #86140



Keel Roller Bracket

Adjustable offset brackets mount on tongue for keel support. Assembled version comes complete with 4" rubber roller (for 2" wide tongue) and hardware as shown. Brackets are available in pairs or bulk.

Description	Part #
Keel Roller Assembly w/roller (1 per)	86121
Keel Roller Brackets pair (2 per)	86122
Keel Roller Brackets pair (bulk)	86120



Cargo Control

Tie Down Boat Rollers & Accessories

Rollers and Keel Pads



Cargo Control

Tie Down Boat Rollers & Accessories

Available by special order only.

Trailer Hardware



Bolster Brackets (a)			
Size Length	Slot	2-Pack Part #	Bulk Part #
8"	1-1/16"	81195	86130
10"	1-1/16"	81200	86131
12"	1-1/16"	81250	86132

Bolster Brackets

Bolster brackets are designed to support bolster or bunk boards. Slotted for vertical adjustment and feature non-slip dimples to avoid movement and increase load capacity. Packaged in pairs with swivel brackets and bolts with nyloc nuts.

Bolster Brackets With Swivel Brackets (b)			
Size Length	Slot	2-Pack Part #	Bulk Part #
8"	1-1/16"	81210	81211
10"	1-1/16"	81215	81216
12"	1-1/16"	81220	81221

Bunk Brackets

Heavy 11 gauge hot dip galvanized steel brackets mount 2" bunks on edge. Slotted for vertical adjustment to standard or deep-V hulls.

Bracket Length	Slot Length	2-Pack Part #	Bulk Part #
9-1/2"	6"	81225	86125
12-5/8"	9-1/8"	81230	86126
8"	4-1/2"		86149



Bunk Boards

Heavy-duty replacement bunk boards come in three sizes, 3', 4', and 5' lengths. Black marine grade carpet provides a smooth surface for your boat to easily slide on or off. Sold in pairs.

Description	Part #
3'	86127
4'	86128
5'	86129



Bunk Board Carpet

All weather carpet is designed to replace worn and frayed bunks on your trailer. The marine grade carpet will not rot or mildew. Each roll measures 11" x 12'.

Black Part #86137
Gray Part #86138

Cargo Control

Boat Anchors

Available by special order only.

Hooker ANCHORS

Hooker Quik-Set

This innovative anchor replaces the Economy anchor line with a fresh design and increased performance. The Hooker Quik-Set has 50% more holding power and the appearance of an anchor costing much more. The Hooker Quik-Set design with the "Slip Lock" shank insures a proper set regardless of which way the anchor lands. A slip design permits easy retrieval in snag prone areas. Hot Dipped Galvanized Finish



Super Hooker

"The Super Hooker anchor is a good choice for your anchoring needs. This lightweight, hot dipped galvanized Super Hooker anchor has strong wide flukes that penetrate quickly and firmly for maximum holding power. The fully welded crown configuration provides the right angles for ultimate holding power and secure penetration. The Super Hooker stows flat and can be used with most fluke type anchor storage systems."

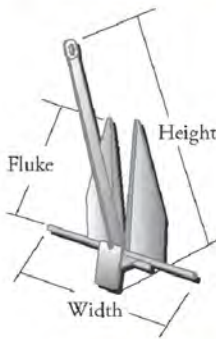

Hooker Quik-Set

Part #	Model Size	Weight	Boat Length	Holding Power	Anchor Height	Stock Width	Fluke Height
95006	5HQ	3.5#	10' to 15'	120#	14"	11-1/2"	9"
95011	7HQ	4.5#	15' to 19'	150#	17"	14-1/2"	9-1/2"
95016	10HQ	5#	20' to 24'	160#	20"	14-1/2"	10"
95021	13HQ	6.5#	25' to 28'	180#	24"	18-1/4"	11-3/4"
95026	15HQ	8#	28' to 30'	200#	24-1/2"	18-1/4"	14-1/2"

Super Hooker

Part #	Model Size	Weight	Boat Length	Holding Power	Anchor Height	Stock Width	Fluke Height
95030	#2-1/2	3#	to 12'	130#	17-1/4"	13"	9"
95035	#4	4#	12' to 16'	240#	19-1/2"	14-3/4"	10-1/2"
95040	#8	9#	17' to 24'	480#	24"	18-1/4"	12"
95045	#13	14#	25' to 30'	740#	28-1/4"	21-1/2"	14-1/4"
95050	#18	18#	31' to 34'	1,050#	31-3/4"	24"	16-1/2"
95055	#22	25#	35' to 38'	1,300#	35"	26-3/4"	19"
95060	#40	43#	38' to 43'	1,600#	40-3/4"	31"	22"
95065	#65	75#	44' to 53'	2,400#	50"	38"	26-1/2"
95070	#85	96#	54' to 60'	2,800#	54"	41"	28-3/4"

Cargo Control & Accessories

Cargo Control

Boat Bunks & Guides

Available by special order only.
Trailer Guides and Bunks



1-3/4" x 17" (8 Pieces)
Part #86170

Bunk Slicks

Bolts directly onto carpeted bunk boards. Fits 2" x 6" or 2" x 4" standard bunk boards. Slide on or off with less effort. Easy to Install.



3" x 16" (10 Pieces)
Part #86164

Modular Bunk Glide On's

Self centering bunk glide on's with interlocking modular sections. Designed to fit various bunk board lengths. Ideal for painted, fiberglass, or aluminum boats. Fits 2" x 6" x 8' standard bunk boards. Kit includes 4 ea. - 3' sections, 4 ea. - 1' end sections and mounting hardware. Slide on or off with less effort. Easy to Install.

Black Part #86295
White Part #86296



3' and 1'
Modular Sections

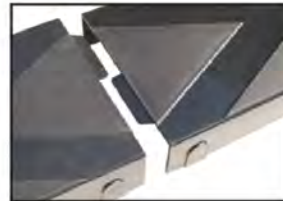

Interlocking Modular
Design



Bunk Glide On's

Self centering bunk glide on's made with Tie Down's enhanced PVC. Launch and load made easy! Ideal for painted, fiberglass, or aluminum boats. Fits 2" x 6" or 2" x 4" standard 8' bunk boards. Slide on or off with less effort. Easy to Install.

2" x 4" Bunk Glide On's Part #86162



2' Part #86123

Bunk Board Guide On
All hardware is hot dip galvanized for corrosion protection and fits frames up to 4-1/4" in size. The bunk boards mount 19" above your trailer frame and have 13" of side movement on each side. Sold in pairs with all hardware included.



5' Part #86124

Cargo Control

Boat Bunks & Guides

Available by special order only.



Pontoon Trailer Guide On's

New!

Bright orange end caps on these PVC guides give you a brighter target when loading your pontoon boat. The guide posts are designed to be mounted between the pontoons. Made of 1-1/2" square, 16-gauge steel tubing and covered by 2"x 20" PVC pipe. Hot dip galvanized guide posts extend fully into the PVC tube for additional strength. Mounts to trailer cross members up to 2" wide by 2" high. All mounting hardware included.

Part #86465

High Impact Pontoon Trailer Guide On's

New!

Ideal for larger pontoon boats. These guides are designed for rough water loading where high impact guides are required. The guide posts are hot dip galvanized for long life with covers made from high impact non-marking molded PVC. The guide posts are designed to be mounted between the pontoons. Made of 2-1/2" square, 13-gauge steel tubing. Mounts to trailer cross members up to 2" wide by 2" high. All mounting hardware included.

Part #86467



Low Rider Guide On's

New!

Ideal for jon boats, bass boats and personal watercraft. The guide posts are hot dip galvanized for long life with covers made from high impact non-marking molded PVC. Low Rider Guide On's give you the extra advantage of high strength and great looks for your trailer. Made of 1-1/2" square, 16-gauge steel tubing and covered with wrap around protective PVC molded covers. Mounts to trailer cross members 2" by 2" and 2"x 3" frames. All mounting hardware included.

Part #86466



Cargo Control

Jet Ski Lift

Jet Rail *Jet Rail XL*

The Jet Rail and Jet Rail XL are all galvanized steel PWC lift designed for easy one person "launch and load". The small foot print under the ski allows easy walk around while the watercraft is stored on the dock or seawall. The brake wench and mount adjusts to any size watercraft and slides inside the lift when not in use, saving even more precious dock space. Carpeted bunk boards and all hardware are included. All you add is your PWC!

Jet Rail
Jet Rail XL

Maximum Weight is 650# (Including gas & oil)
Maximum Weight is 950# (Including gas & oil)

Part #27277
Part #27377



Jet Rail



Jet Rail XL



Tie Down Mate Kit

Includes Tie Down Mate, 15' anchor line, float and a nylon carry bag. Ideal for mooring personal watercraft or small boats. Screws in easily. Removable handle stows inside anchor tube.

Part #86072

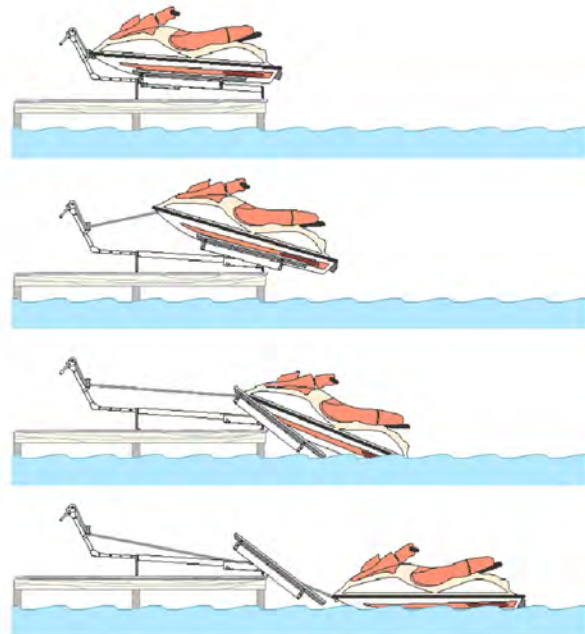

Tie Down Mate

The original beach security anchor from Tie Down. Ideal for mooring personal watercraft or small boats. Screws in easily. Removable handle stows inside anchor tube.

Part #86071

Available by special order only.

Cargo Control

RV Covers AC Covers



CL77414



CL77440



CL77863

A: Size Min B: Size Max

Item Number	Description	Color	SO	A	B	C	Extra Info
CA80-030	Travel Trailer Cover	Gray	Yes	24ft	27ft	Classic	PolyX 300
CL74203	Folding Camping Trailer Cover	Gray	Yes	8ft	10ft	Classic	Poly
CL75863	RV 5th Wheel Cover	Gray	Yes	29ft	33ft	Classic	104in Tall
CL77410	RV A/C Cover	Snow White	Yes	N/A	N/A	Classic	Coleman/Mach I-II-III/Mach 3 Plus/Mach 15/Roughneck/TSR
CL77420	RV A/C Cover	Snow White		N/A	N/A	Classic	Duo-Therm/Briskair/Quick Cool
CL77440	RV A/C Cover	Snow White		N/A	N/A	Classic	Carrier/Air V
CL77863	RV Cover	Snow White	Yes	40ft	42ft	Classic	Extra Tall Class A
CL78654	RV Windshield Cover	Snow White		N/A	N/A	Classic	Chevy/GMC '73-'96
CL78674	RV Windshield Cover	Snow White		N/A	N/A	Classic	Ford 73-91
CL78684	RV Windshield Cover	Snow White		N/A	N/A	Classic	Ford 92-03

Tank Covers

A: Tank Size

Item Number	Description	Color	A	B
CL79720	RV Tank Cover	Snow White	20-5Ga	Classic
CL79730	RV Tank Cover	Snow White	30-7.5Ga	Classic

CL79720



Cargo Control & Accessories

Cargo Control

Tarps Roll Tarps

A: Width B: Length C: Mfg.



B3008976



DTR8022



DTR6515

Item Number	Description	Color	SO	A	B	C
3001894	Roll Tarp Universal Joint	Zinc Plated	Yes	3/8ph	1-3/8in	Buyers
3001895	Roll Tarp Male 21 Spline	Zinc Plated		N/A	1-13/16in	Buyers
3008308	Rear PVC Bar Kit for DTB102	White		N/A	5in	Buyers
3008309	Rear Washer Guide Bar Kit	----		4in OD	N/A	Buyers
57056	Heavy Duty Tarp	Black Mesh		6ft	8ft	Erickson
57057	Heavy Duty Tarp	Black Mesh		8ft	10ft	Erickson
57058	Heavy Duty Tarp	Black Mesh		10ft	12ft	Erickson
57059	Heavy Duty Tarp	Black Mesh		12ft	16ft	Erickson
B3008176A	Handle Replace DTR7020	----		----	----	Buyers
B3008209	Tarp	Black Mesh		7-1/2ft	15ft	Buyers
B3008210	Tarp	Black Mesh		7ft	15ft	Buyers
B3008976	Tarp	Black Mesh		6-1/2ft	15ft	Buyers
B3009094	Tarp	Black Mesh		6-1/2ft	18ft	Buyers
B3009455	Tarp	Black Mesh		6ft	14ft	Buyers
B3009456	Tarp	Black Mesh		7ft	18ft	Buyers
B3009892	Tarp	Black Mesh		8ft	22ft	Buyers
B3011035	Tarp	Black Mesh		7-1/2ft	12ft	Buyers
B3011351	Tarp	Black Solid		7ft	18ft	Buyers
B3011353	Tarp	Black Solid	Yes	7-1/2ft	15ft	Buyers
B3011354	Tarp	Black Solid	Yes	7-1/2ft	20ft	Buyers
B3013397	Tarp	Black Mesh	Yes	7-1/2ft	24ft	Buyers
DTB102	Rear Anti-Sail Tarp Retention Bow	Black Solid		----	----	Buyers
DTR	Tarp Roller Kit-No Tarp	Zinc Plated	Yes	up to 102in	N/A	Buyers
DTR4510	Tarp Roll Kit	Black Mesh	Yes	4-1/2ft	10ft	Buyers
DTR5514	Tarp Roll Kit	Black Mesh		5-1/2ft	14ft	Buyers
DTR6014	Dump Tarp Roll Kit	Black Mesh		6ft	14ft	Buyers
DTR6515	Dump Tarp Roll Kit	Black Mesh		6-1/2ft	15ft	Buyers
DTR6518	Dump Tarp Roll Kit	Black Mesh		6-1/2ft	18ft	Buyers
DTR7015	Dump Tarp Roll Kit	Black Mesh		7ft	15ft	Buyers
DTR7018	Dump Tarp Roll Kit	Black Mesh		7ft	18ft	Buyers
DTR7018S	Dump Tarp Roll Kit	Black Solid		7ft	18ft	Buyers
DTR7512	Dump Tarp Roll Kit	Black Mesh		7-1/2ft	12ft	Buyers
DTR7515	Dump Tarp Roll Kit	Black Mesh		7-1/2ft	15ft	Buyers
DTR7515S	Dump Tarp Roll Kit	Black Solid		7-1/2ft	15ft	Buyers
DTR7518	Dump Tarp Roll Kit	Black Mesh		7-1/2ft	18ft	Buyers
DTR7520	Dump Tarp Roll Kit	Black Mesh		7-1/2ft	20ft	Buyers
DTR8022	Dump Tarp Roll Kit	Black Mesh		7-1/2ft	22ft	Buyers

Cargo Control

Locks Padlocks



A: Diameter B: Tall C: Width D: Mfg.

Item Number	Description	SO	A	B	C	D
140D	Brass Cabinet Lock		1/4in	7/8in	13/16in	Master
175D	Combination Lock		5/16in	1in	1in	Master
3008D	Residential Lock Keyed Alike 4pk		9/32in	3/4in	5/8in	Master
312TR1	Blue Weather Resistant Lock 3pk		3/8in	1in	5/8in	Master
3KA	Commercial Master Lock	Yes	9/32in	3/4in	5/8in	Master
3T	Residential Lock Keyed Alike 2pk		9/32in	3/4in	5/8in	Master
40D	Shrouded Lock		3/8in	5/8in	3/4in	Master
40KAD	Shrouded Lock		3/8in	5/8in	3/4in	Master
6121KA	ProSeries Padlock	Yes	5/16in	1-3/8in	7/8in	Master
7018517	GM Early Model Padlock		5/16in	2-9/64in	61/64in	BOLT
7018518	GM Late Model Padlock		5/16in	2-9/64in	61/64in	BOLT
7018519	Ford Padlock		5/16in	2-9/64in	61/64in	BOLT
7018520	Chrysler Padlock		5/16in	2-9/64in	61/64in	BOLT
7045KA	Shrouded Padlock	Yes	5/16in	1-3/16in	29/32in	Master

Wheel Locks

A: Size B: Mfg.

Item Number	Description	Color	A	B
262DAT	Spare Tire Lock	Chrome	1/2in	Master
CU23175	Wheel Chock Lock	Red/Yel	----	Curt
CU23562	Spare Tire Lock	Chrome	1/2in	Curt
WC490	Club Wheel Lock	Red	13-16in	Tuff-Tow
WC491	Claw Wheel Lock	Red	12in	Tuff-Tow



Cargo Control

Locks Cable Locks



A: Length B: Diameter C: Mfg.

Item Number	Description	Color	SO	A	B	C
614DAT	Master Lock w/Cable			6ft	1/4in	Master
7018449	GM Early Model Cable Lock			6ft	1/4in	BOLT
7018450	GM Late Model Cable Lock			6ft	1/4in	BOLT
7018451	Ford Cable Lock			6ft	1/4in	BOLT
7018452	Chrysler Cable Lock			6ft	1/4in	BOLT
8413XDPF	Python Adjustable Cable Lock			6ft	----	Master
8415D	Python Cable Only		Yes	15ft	----	Master
CU23666	Multi-Use Cable Lock			6ft	10mm	Curt
ST30	Tire Lock Cable	Black		N/A	N/A	Trimax
TFA6	Wall/Floor Anchor Lock		Yes	N/A	N/A	Trimax
TH538	Cable Lock		Yes	6ft	----	Thule
VMAX6	Versatile Cable Lock			6ft	10mm	Trimax

WaterCraft Locks

A: Mfg.



T6

Item Number	Description	SO	A	B
T6	Water Craft Lock	Yes	5-1/2x1/2in	Trimax

Gun Locks

A: Mfg.



TGCL44

TGL22

Item Number	Description	SO	A
TGCL44	Max Security Gun Lock	Yes	Trimax
TGL22	Max Security Keyed Gun Lock	Yes	Trimax

Cylinder Locks

A: Mfg.



19CH545

39LL71

88CH545

Item Number	Description	SO	A
19CH545	Cylinder & Keys		Buyers
39LL71	Cylinder 39 & LI71 Key	Yes	Buyers
88CH545	Cylinder & CH545 Key		Buyers

Cargo Control

Locks Specialty Locks



A: Size B: Mfg.

Item Number	Description	SO	A	B
185-12001-4	Ladder Lock Fits 2 Ladders		----	Keeper
6270	Hidden Shackle Lock		3/8inx2-7/8in	Master
6270KA	Keyed Alike Hidden Shackle Lock	Yes	3/8inx2-7/8in	Master
770	Hidden Shackle Lock Hasp		9x4-1/2in	Master
CK1	Single Camknot Lock		1/4in	Convert-A-Ball
CK2	Pair Keyed Camknot Lock		1/4in	Convert-A-Ball
CK3	Keyed Camknot Lock 3pk		1/4in	Convert-A-Ball
DL-80	Cargo Door Lock		----	Blaylock
SL100	Shielded Security Lock		----	Buyers
SLH100	Security Lock Hasp		----	Buyers
THP3XLKA	Hockey Puck Keyed Lock 3pk		3/8inx2-7/8in	Trimax
THPXL	Hockey Puck Lock		3/8inx2-7/8in	Trimax
THPXLKA	Hockey Puck Keyed Lock	Yes	3/8inx2-7/8in	Trimax
THSP2C	Hidden Shackle For Padlock	Yes	9x4-1/2in	Trimax

Cargo Control

Locks Hitch Locks Bent Pin Style



5200 & 5201
CU23020
CU23021
CU23575
CU23585



TR200
TR200KA



MAG125
MAG200



TT5204



TT5201



7018445 7019341
7018446 7019342
7018447 7019343
7018448 7019344

A: Diameter B: Length C: Mfg.

Item Number	Description	Color	SO	A	B	C
4723039	Display Counter Bolt lock	---		N/A	N/A	Bolt
5200	Receiver Lock Bent Pin	Chrome		1/2in	3in	Buyers
5201	Receiver Lock Bent Pin	Chrome		5/8in	3-5/8in	Buyers
7018445	Receiver Lock Bent Pin GM-A	Chrome		5/8in	3-5/8in	Bolt
7018446	Receiver Lock Bent Pin GM-B	Chrome		5/8in	3-5/8in	Bolt
7018447	Receiver Lock Bent Pin Ford	Chrome		5/8in	3-5/8in	Bolt
7018448	Receiver Lock Bent Pin Chrysler	Chrome		5/8in	3-5/8in	Bolt
7019341	Receiver Lock Bent Pin GM-A	Chrome		1/2in	1.78in	Bolt
7019342	Receiver Lock Bent Pin GM-B	Chrome		1/2in	1.78in	Bolt
7019343	Receiver Lock Bent Pin Ford	Chrome		1/2in	1.78in	Bolt
7019344	Receiver Lock Bent Pin Chrysler	Chrome		1/2in	1.78in	Bolt
CU23020	Receiver Lock	Chrome		1/2in	3in	Curt
CU23021	Receiver Lock Bent Pin	Chrome		5/8in	3-5/8in	Curt
CU23575	Receiver Lock	Black	Yes	5/8in	2-5/8in	Curt
CU23585	Receiver Lock	Stainless		5/8in	3-1/4in	Curt
MAG125	Receiver Combination Lock	Chrome		1/2in	2-5/8in	Trimax
MAG200	Receiver Combination Lock	Chrome		5/8in	3in	Trimax
TR200	Lock Bent Style	Chrome	Yes	5/8in	2-5/8in	Trimax
TR200KA	Lock Bent Style Keyed Alike	Chrome	Yes	5/8in	2-5/8in	Trimax
TT5201	Receiver Lock	Chrome		5/8in	2-5/8in	Tuff Tow
TT5204	Receiver Lock	Chrome		5/8in	2-5/8in	Tuff Tow

Cargo Control

Locks Hitch Locks Barrel Style



A: Diameter B: Length C: Mfg.

Item Number	Description	Color	SO	A	B	C
1479DAT	Receiver Lock	Stainless		5/8in	2-5/8in	Master
1480DAT	Receiver Lock	Stainless		5/8in	2-5/8in	Master
1480KA	Receiver Lock	Stainless	Yes	5/8in	2-5/8in	Master
CU23572	Receiver Lock	Chrome		1/2in	2-5/8in	Curt
CU23579	Receiver Lock	Chrome		5/8in	2-5/8in	Curt
CU23583	Receiver Lock	Stainless		5/8in	2-5/8in	Curt
SXT3	Receiver Lock	Stainless		5/8in	2-5/8in	Trimax
SXT5	Receiver Lock	Stainless		5/8in	3-1/4in	Trimax
T2	Receiver Lock	Chrome		1/2in	2-5/8in	Trimax
T3	Receiver Lock	Chrome		5/8in	2-5/8in	Trimax
T-3 BLACK	Premium Key Receiver Lock	Black		5/8in	2-5/8in	Trimax
T3CAP	Rubber Lock Cap	Black		N/A	N/A	Trimax
T3FL	Receiver Lock	Chrome		5/8in	2-5/8in	Trimax
T3KA	Lock Keyed Alike	---	Yes	5/8in	2-5/8in	Trimax
T5	Receiver Lock	Chrome		5/8in	3-1/4in	Trimax
TH4	Receiver Lock	Chrome		5/8in	4-3/8in	Trimax
TK225	Receiver Lock	Chrome		5/8in	2-5/8in	Trimax
TS50796	Receiver Pro Lock	---		5/8in	2-5/8in	B&W

Anti-Rattle

A: Diameter B: Mfg.

Item Number	Description	Color	A	B
CU23590	Anti-Rattle Receiver Lock	Stainless	5/8in	Curt



Cargo Control

Hitch Locks Universal



2866DAT



CU23024



CU23580



TT5203

A: Diameter 1 B: Diameter 2 C: Span

Item Number	Description	Color	A	B	C	Extra Info
2866DAT	Receiver Lock	Chrome	5/8in	1/2in	3in	Master
CU23024	Receiver Lock	Chrome	1/2in	5/8in	2-5/8in	Curt
CU23580	Receiver Lock	Stainless	5/8in	----	2-5/8in	Curt
TT5203	Receiver Lock	Chrome	5/8in	1/2in	2-5/8in	Tuff Tow

Kit



2848DAT



TCP50
TCP50KA

CU23556



TM32



SXTM31
TM31



TH43
TH45

A: Span 1 B: Diameter 1 C: Span 2 D: Diameter 2 E: Mfg.

Item Number	Description	Color	A	B	C	D	E
2848DAT	Receiver & Coupler Lock Set	Stainless	2-3/4in	5/8in	2-3/4in	1/2in	Master
CU23556	Receiver Lock Kit	Chrome	2-5/8in	5/8in	4-1/4in	5/8in	Curt
CU23574	Receiver Lock Kit	Chrome	2-5/8in	5/8in	7/8in	1/4in	Curt
SXTM31	Receiver Lock Kit	Stainless	2-5/8in	5/8in	7/8in	1/4in	Trimax
TCP50	Universal Lock Keyed Alike	Gray	2-5/8in	5/8in	7/8in	1/4in	Trimax
TCP50KA	Universal Lock Keyed Alike	Gray	2-5/8in	5/8in	7/8in	1/4in	Trimax
TH43	Receiver Lock Kit	Chrome	2-5/8in	5/8in	4-1/2in	5/8in	Trimax
TH45	Receiver Lock Kit	Chrome	3-1/2in	3/8in	4-3/8in	5/8in	Trimax
TM31	Receiver Lock Kit	Chrome	2-5/8in	5/8in	7/8in	1/4in	Trimax
TM32	Receiver Lock	Chrome	2-5/8in	5/8in	2-1/2in	1/4in	Trimax

Cargo Control

Locks Coupler Locks 2in Ball



A: Ball Size B: Mfg.

Item Number	Description	Color	A	B
36	Coupler Lock	Painted	2in	Master
G46	Forged Coupler Lock	Painted	2in	Tuff-Tow

2-5/16in Ball



A: Ball Size B: Mfg.

Item Number	Description	Color	A	B
378DAT	Coupler Lock	Stainless	2-5/16in	Master
39	Coupler Lock	Painted	2-5/16in	Master

Kit



A: Span 1 B: Diameter 1 C: Span 2 D: Diameter 2 E: Ball Size F: Mfg.

Item Number	Description	Color	A	B	C	D	E	F	Extra Info
3784DAT	Coupler Lock Kit	Laminated	----	----	----	----	2-5/16in	Master	Keyed Alike
3794DAT	Coupler Lock Kit	Chrome	3-3/4in	5/8in	2-3/4in	1/2in	1-7/8-2-2-5/16	Master	Keyed Alike

Cargo Control

Locks Coupler Locks Universal



A: Ball Size B: Ball Size C: Ball Size D: Mfg.

Item Number	Description	Color	SO	A	B	C	D	Extra Info
34	Coupler Lock	Painted		1-7/8in	2in	N/A	Master	----
377DAT	Coupler Lock Universal	Stainless		1-7/8in	2in	N/A	Master	----
377KA 0340	Coupler Lock Universal	Chrome	Yes	1-7/8in	2in	N/A	Master	Keyed Alike
377KA 0501	Coupler Lock Universal	Chrome	Yes	1-7/8in	2in	N/A	Master	Keyed Alike
378KA 0340	Coupler Lock Universal	Silver	Yes	N/A	N/A	2-5/16in	Master	Keyed Alike
379DAT	Coupler Lock Universal	Black		1-7/8in	2in	2-5/16in	Master	----
CU23079	Coupler Lock R-Lip	Gray		N/A	2in	2-5/16in	Curt	2 Keys
CU23179	Coupler Lock Universal	Black		N/A	N/A		Curt	----
CU23659	Coupler Lock Universal	Hammer Tone		1-7/8in	2in	2-5/16in	Curt	----
TCL1-AS	Coupler Lock R-Lip	Gray		1-7/8in	2in	N/A	DeadBolt	2 Keys
TCL2-AS	Coupler Lock R-Lip	Gray		N/A	2in	2-5/16in	DeadBolt	2 Keys
UMAX100	Receiver Lock All Couplers	Chrome/Black		1-7/8in	2in	2-5/16in	Trimax	----
UMAX100KA	Coupler Lock Universal	Chrome/Black	Yes	1-7/8in	2in	2-5/16in	Trimax	Keyed Alike
UMAX50	Universal Dual Coupler Lock	Gray		1-7/8in	2in	2-5/16in	Trimax	----
UMAX50 K#	Coupler Dual Lock Universal	Gray		1-7/8in	2in	2-5/16in	Trimax	2 Keys
UMAX50KA	Coupler Dual Lock Universal	Gray	Yes	1-7/8in	2in	2-5/16in	Trimax	Keyed Alike

Cargo Control

Locks Coupler Locks Latch Lock



1475DAT



2847DAT



3008
CU23022
TT3008



605DAT
CU23546



CU23541
SXTC1
TC-1



CU23542
CU23544
TC-2
TC-2KA
TC-3



CU23547
SXTC123
TC123

A: Span B: Diameter C: Mfg.

Item Number	Description	Color	SO	A	B	C	Extra Info
1475DAT	Coupler Lock	Gold		7/8in	9/32in	Master	----
2847DAT	Coupler Lock Adjustable	Stainless		2-3/4in	9/32in	Master	6 Post ADJ
3008	Coupler Lock	Gold		3/4in	1/4in	Buyers	----
605DAT	Coupler Lock	Brass		3/4in	9/32in	Master	----
CU23022	Coupler Lock	Brass		3/4in	1/4in	Curt	2 Keys
CU23541	Coupler Lock	Stainless		1/2-7/8in	7mm	Curt	----
CU23542	Coupler Lock	Stainless		2-1/2in	7mm	Curt	----
CU23544	Coupler Lock Surge Brake	Chrome		3-3/8in	1/4in	Curt	----
CU23545	Coupler Lock Universal	Zinc		3/4in	1/4in	Curt	----
CU23546	Coupler Lock	Brass		3/4in	3/8in	Curt	----
CU23547	Coupler Lock	Stainless		2-5/8in	N/A	Curt	----
SXTC1	Coupler Lock	Stainless	Yes	7/8in	1/4in	Trimax	----
SXTC123	Multi-fit Coupler Lock	Stainless		7/8in	----	Trimax	Up to 3-1/2 Span
TC-1	Coupler Lock	Stainless		7/8in	1/4in	Trimax	----
TC123	Coupler Lock	Chrome		7/8in	1/2in	Trimax	Up to 3-1/2 Span
TC-2	Coupler Lock	Chrome		2-1/2in	1/4in	Trimax	----
TC-2KA	Coupler Lock	Chrome		2-1/2in	1/4in	Trimax	----
TC-3	Coupler Lock Surge Brake	Chrome		3-1/2in	1/4in	Trimax	----
TMC10	Coupler Lock	Chrome		7/8in	1/4in	Trimax	----
TT3008	Coupler Lock	Brass		3/4in	1/4in	Tuff-Tow	2 Keys

Lunette

A: Ring ID C: Mfg.

Item Number	Description	Color	A	B
4210	Coupler Lock Lunette	Zinc	2-1/2-3in	Buyers



Cargo Control

Locks Coupler Locks King Pin



CU23155



CU23255



KPL200



TFW55

A: King Pin Diameter B: Mfg.

Item Number	Description	SO	A	B
CU23155	5th Wheel King Pin Lock		N/A	Curt
CU23255	King Pin Lock Dumbbell Style		5/8inx2in	Curt
KPL200	King Pin Lock		2in	Buyers
TFW55	5th Wheel King Pin Lock	Yes	2in	Trimax

Gooseneck

2989AT



TT-55



A: Mfg.

Item Number	Description	A
2989AT	Universal Gooseneck Lock	Master
TL-55	RAM Base Gooseneck Lock	Blaylock